

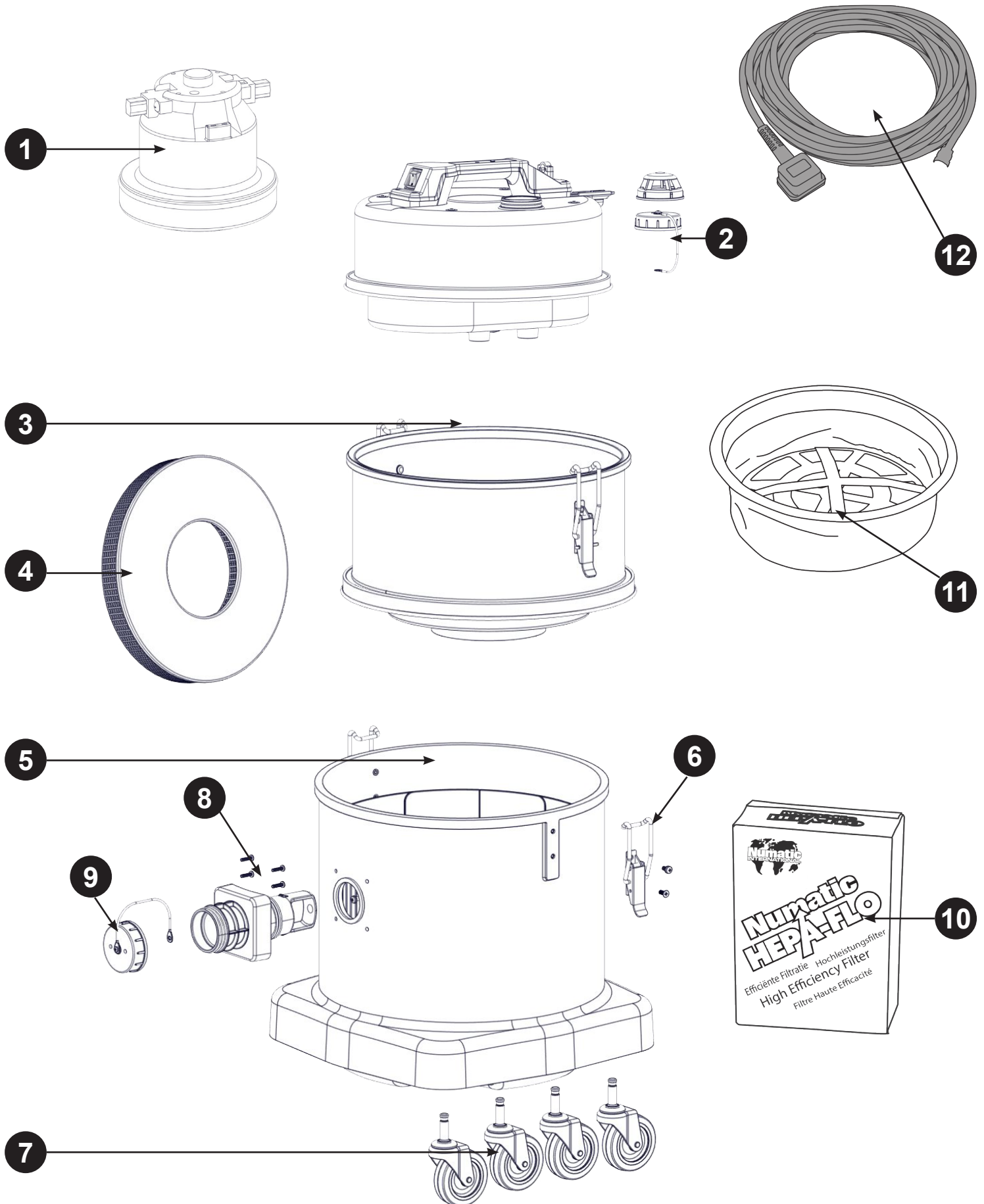

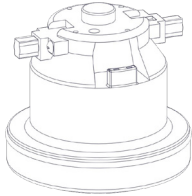





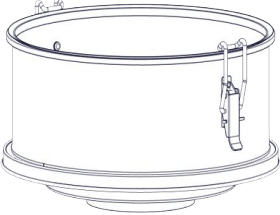

MV570 / MVD570A Exploded Spares

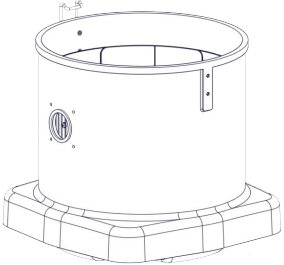
M Class Dust Extraction

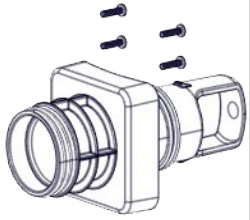

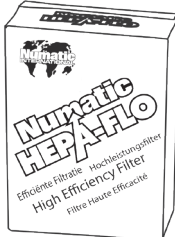
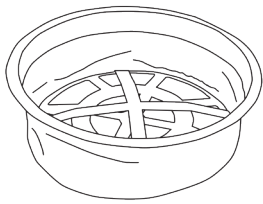
| Item Number | Image Reference | Item Description | Part Number | Item Quantity |
|-------------|---|---|------------------------------------|---------------------|
| 1 |  | (MV) 230V 2 STAGE WITH TCO (DL21104T) MOTOR (HZQ 450/750) 3 CORE 120V 2 STAGE + TCO (DL21101T) MOTOR ASSY (HZQ 450/750) 3CR [2] PREVIEW (MVD) 230V 2 STAGE THRU FLOW TAPER FAN MOTOR | 323070 323072 205403 | 1 1 2 |
| 2 |  | AIR DIFFUSER FOR BLOWER TYPES (NVM-51) BLANKING CAP | 604151 206363 | 1 1 |
| 3 |  | (MV) SIMPLEX MICRO GREY INTERCEPTOR (MVD) DUPLEX MICRO GREY INTERCEPTOR | 502056 502057 | 1 1 |
| 4 |  | MV H13 FILTER ASSEMBLY MVD H13 FILTER ASSEMBLY | 901647 901652 | 1 1 |
| 5 |  | MV/MVD 570 GREY DRUM ASSEMBLY (WITH FINE DUSTLINER/BAG CONNECTOR) | 525041 | 1 |
| 6 |  | BLACK TOGGLE FASTENER 30-1665 MSBL | 303637 | 2 |
| 7 |  | 3 INCH STEM FITTING CASTOR | 204060 | 4 |

| Item Number | Image Reference | Item Description | Part Number | Item Quantity |
|-------------|---|--|--------------------------------------|------------------|
| 8 |  | NDD BAYONET BAG CONNECTOR FRONT HOSE FLANGE GASKET BAYONET SEAL NDD BAYONET BAG CONNECTOR TUBE | 305038 202027 202102 237342 | 1 1 1 1 |
| 9 |  | 150MM LONG FIXING WIRE [1] BLANKING CAP [1] | 303037 206363 | 1 1 |
| 10 |  | BOX OF 10 NVM-3BH HEPAFLO BAGS | 604017 | 1 |
| 11 |  | 14 INCH WHITE FILTER ASSEMBLY | 604116 | 1 |
| 12 |  | (MV) YELLOW.10000.1.3.UK PLUG.10A SOCKET PLUG 10MT X 3 CORE X 1.5MM CABLE PLUS 16AMP INDUSTRIAL PLUG (MVD) 10 METRE X 1.5MM X 3 CORE CABLE SOCKET PLUG | 911757 236050 236011 | 1 1 1 |

MV 570 / MVD570A Accessories

| 607335 | Kit BS5 | | |
|--------|------------------------------------|--------|--|
| 602102 | 2.4m NuFlex Threaded Hose (38mm) | 602381 | 40mm ProFlo Brush Tool |
| 602919 | Stainless Steel Tube Bend | 602162 | 152mm Rubber Brush with Stiff Bristles |
| 602920 | Stainless Steel Tube Extension x 2 | | |

Numatic International Limited. Chard, Somerset TA20 2GB
ENGLAND Tel: 01460 68600 www.numatic.co.uk

Numatic International GmbH. Fränkische Straße 15–19. D-30455 Hannover,
DEUTSCHLAND Tel: 05 11 98 42 16 0 www.numatic.de

Numatic International SAS. 13 / 17 rue du Valengelier. EAE La Tuilerie – 77500
CHELLES, FRANCE Tel: 01 64 72 61 61 www.numatic.fr

Numatic International BV. Vennootsweg 15, 2404 CG, Alphen aan den Rijn,
NEDERLAND Tel: 0172 467 999 www.numatic.nl

Numatic International (Pty.) Ltd. 16th & Pharmaceutical Roads, Midrand, Gauteng,
SOUTH AFRICA 1685 Tel: 0861 686 284 www.numatic.co.za

Numatic International Schweiz AG. Sihlbruggstrasse 3A, 6340 Baar.
SCHWEIZ Tel: 0041 (0) 41 76 80 76 - 0 www.numatic.ch

Numatic International ULDA. Rua da Boa Viagem, 177. 4470.210 Maia.
PORTUGAL Tel: +351 220 047 700 www.numatic.pt

Numatic International SLU. C/ La Forja, 41, 08840 Viladecans. (Barcelona),
SPAIN Tel: +34 93 647 22 22 www.numatic.es

Numatic International DENMARK. Fränkische Straße 15–19. D-30455 Hannover,
DEUTSCHLAND Tel: 05 11 98 42 16 0 www.numatic-online.dk