

MC 5M - MC 6P - MC 7P

Instructions for use

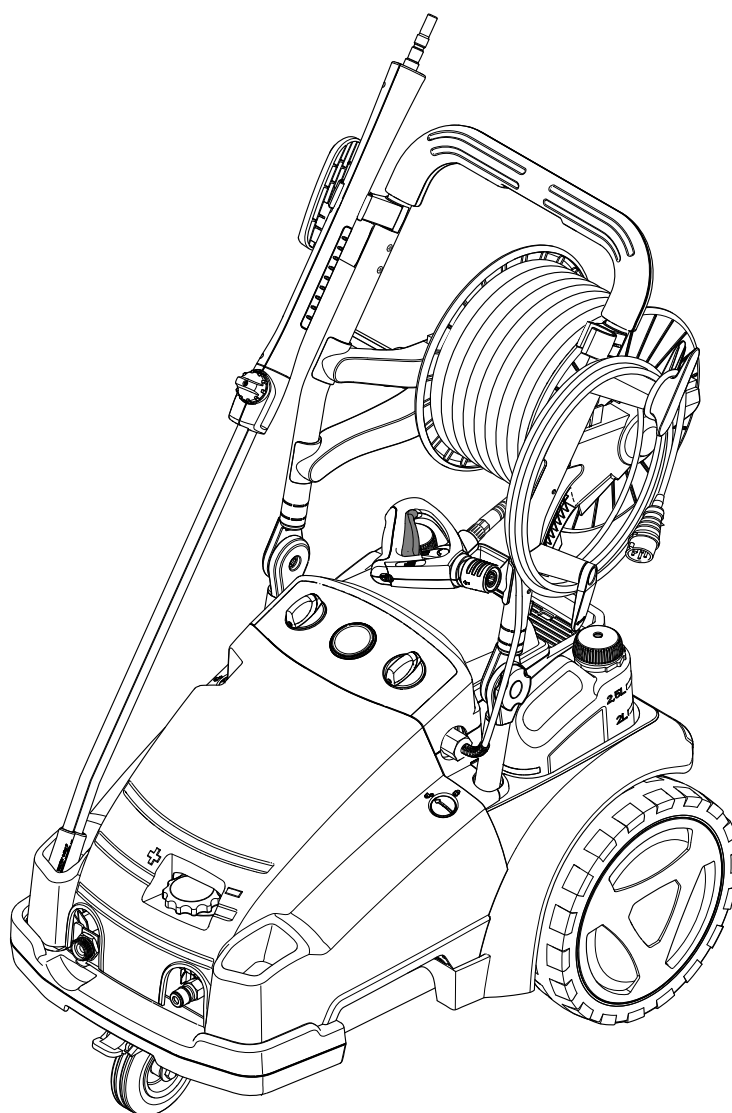

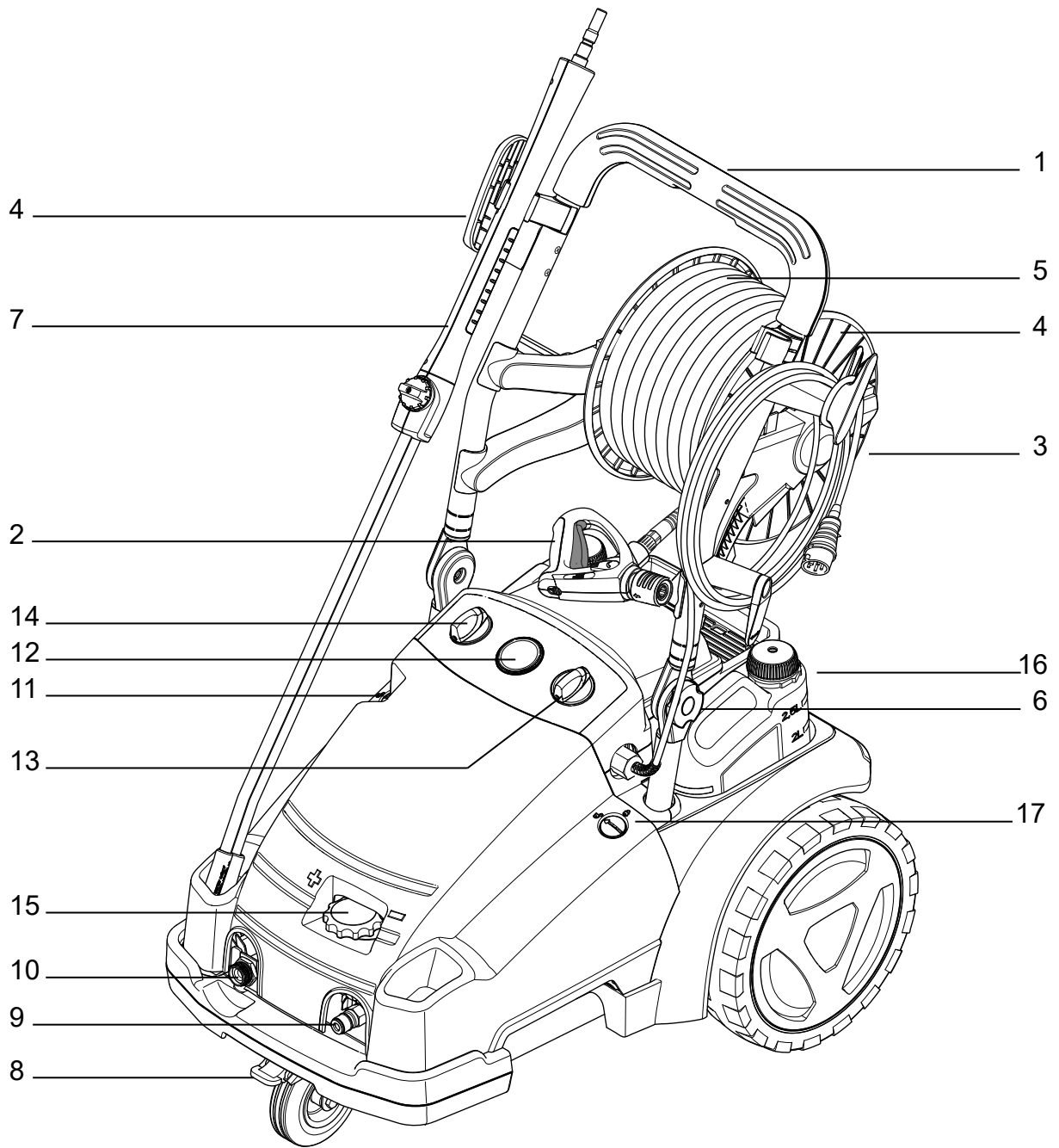

B1

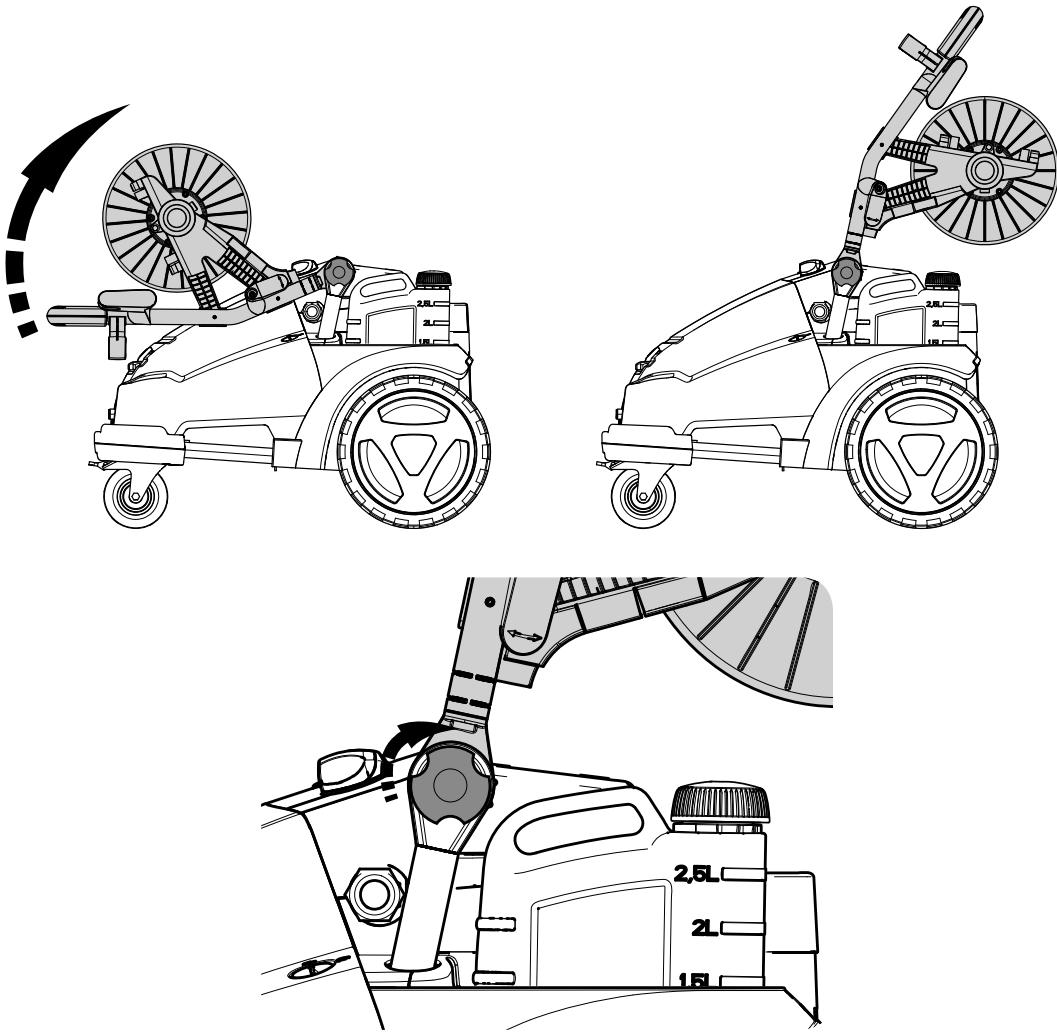

C1

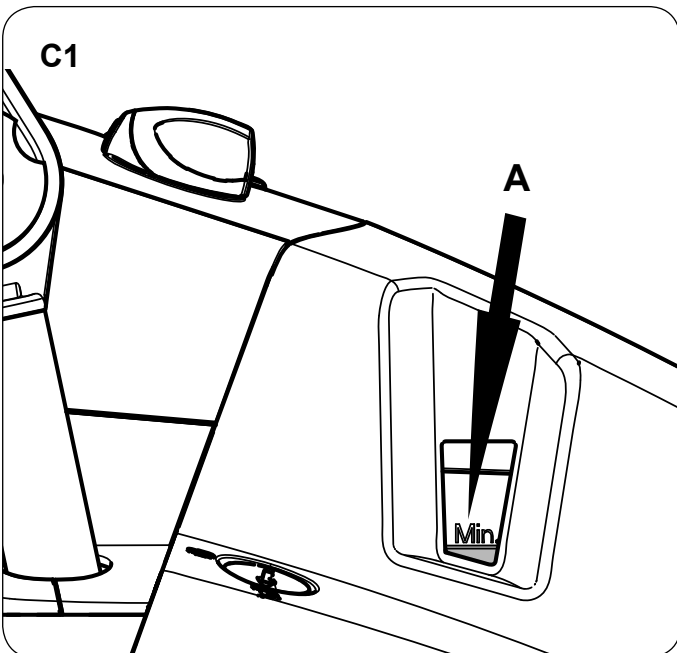

C2

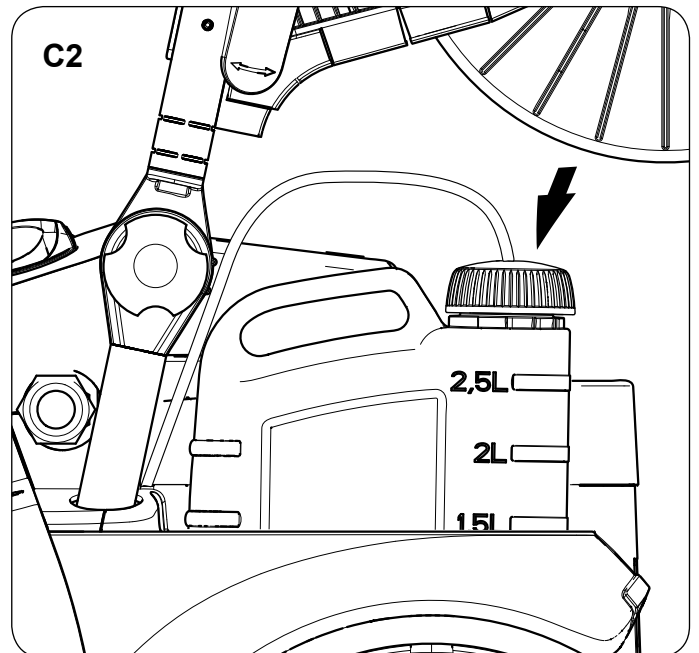

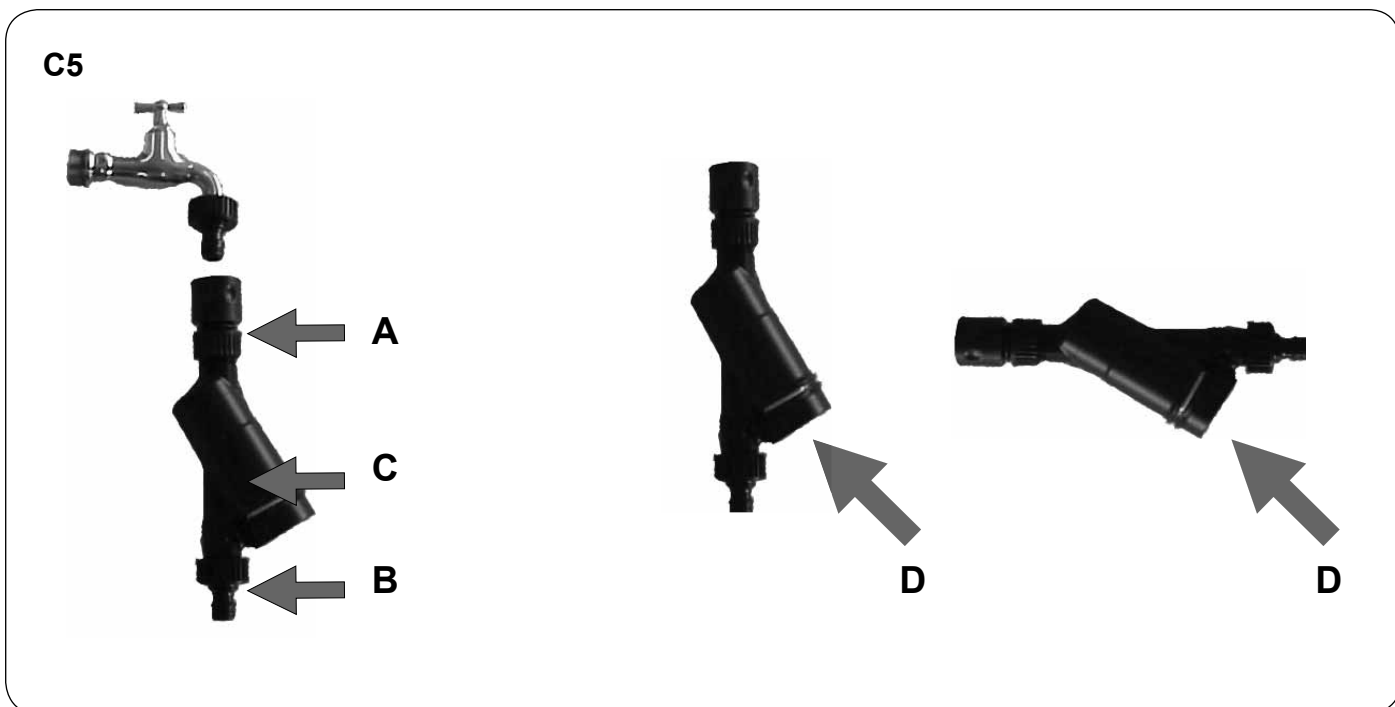
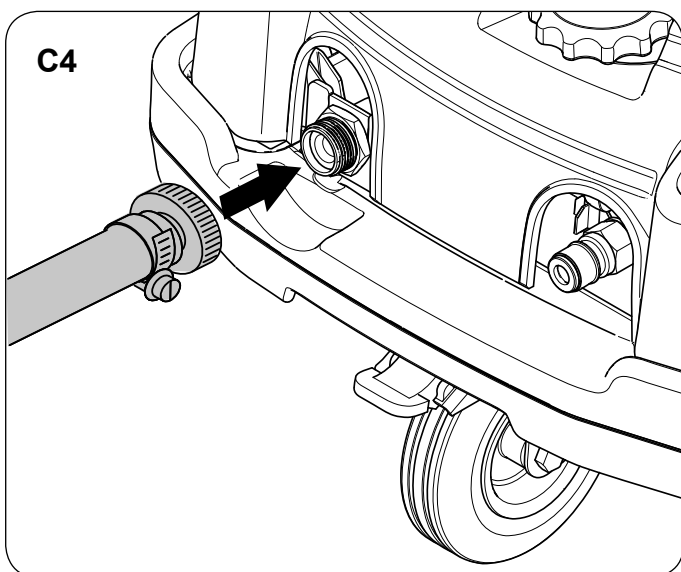
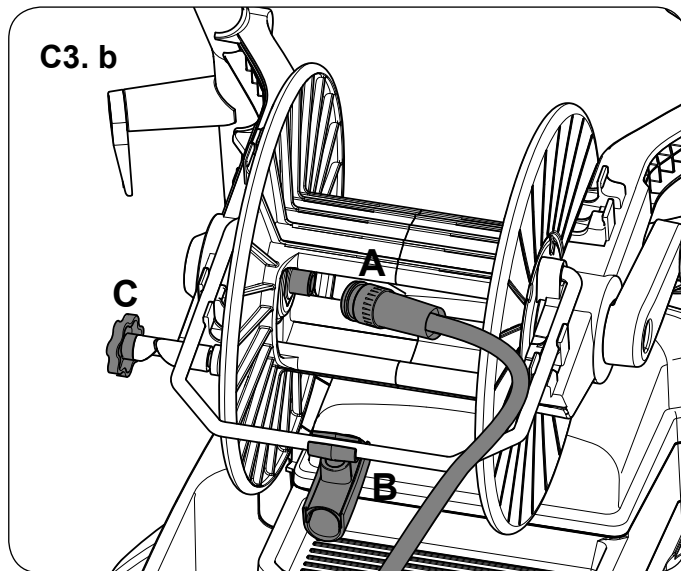
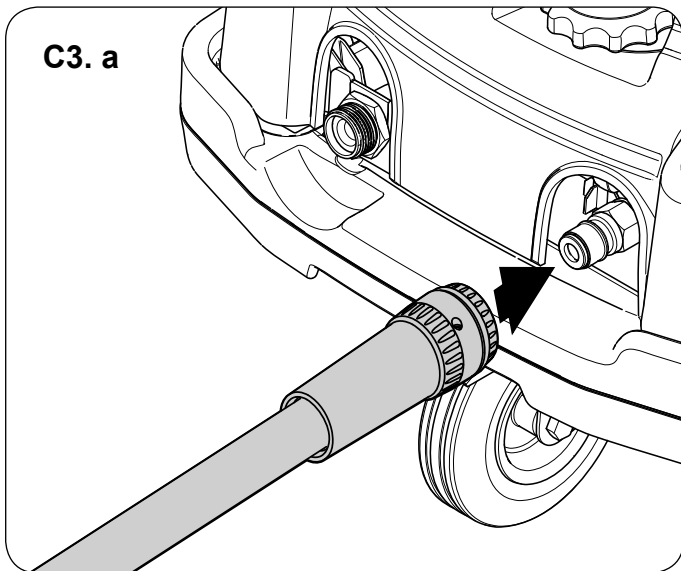

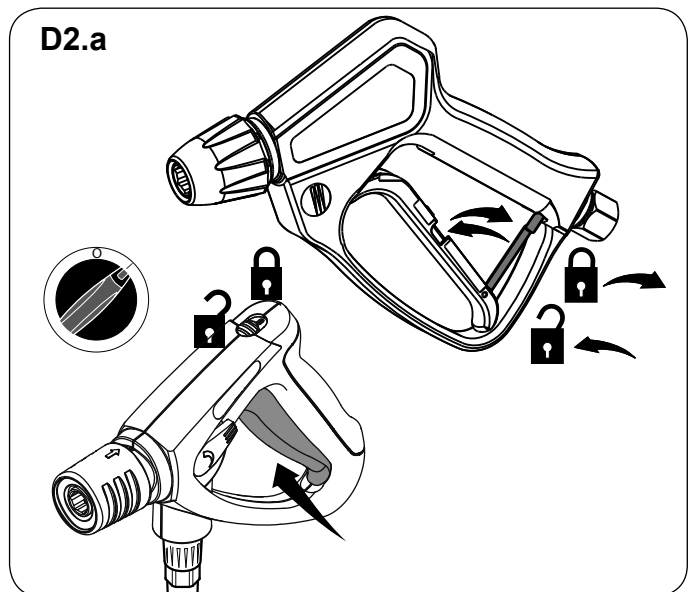
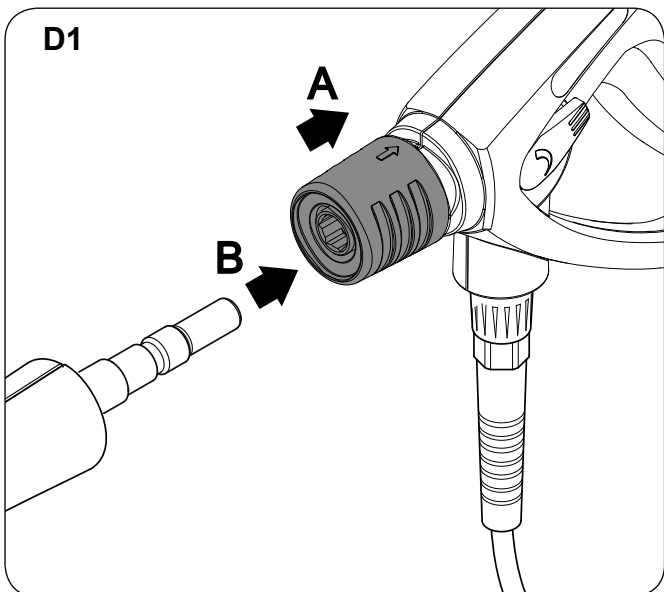
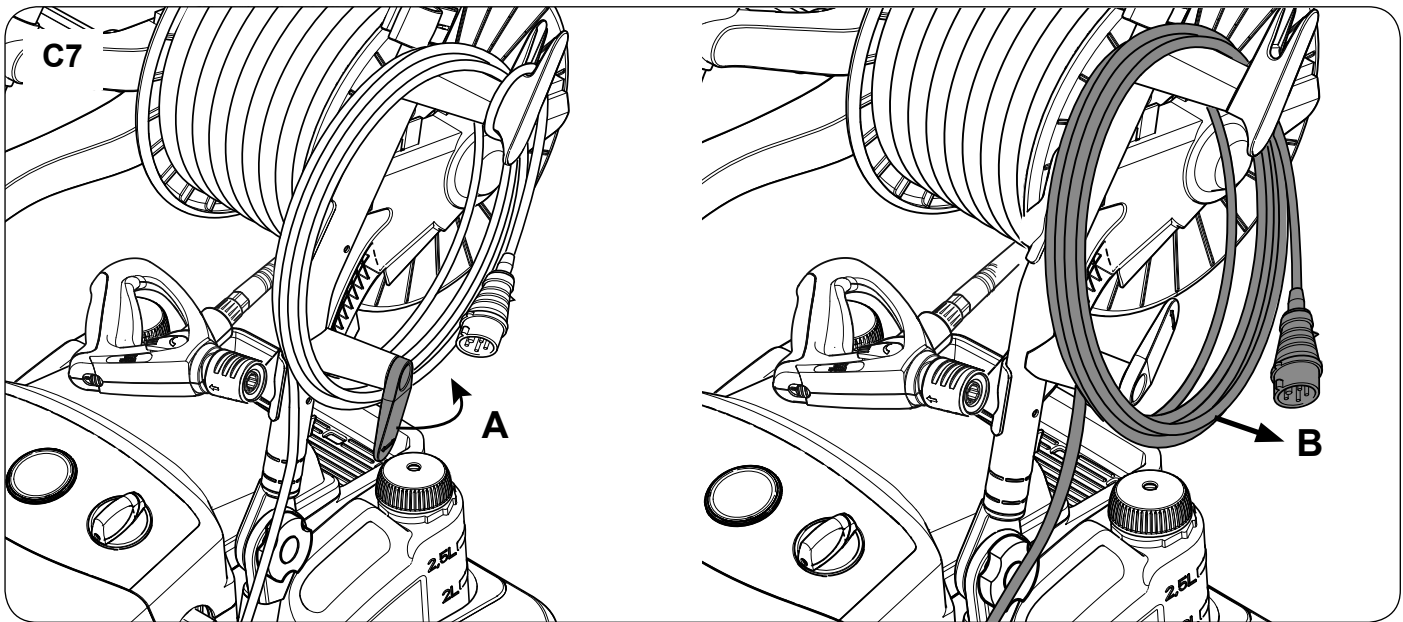
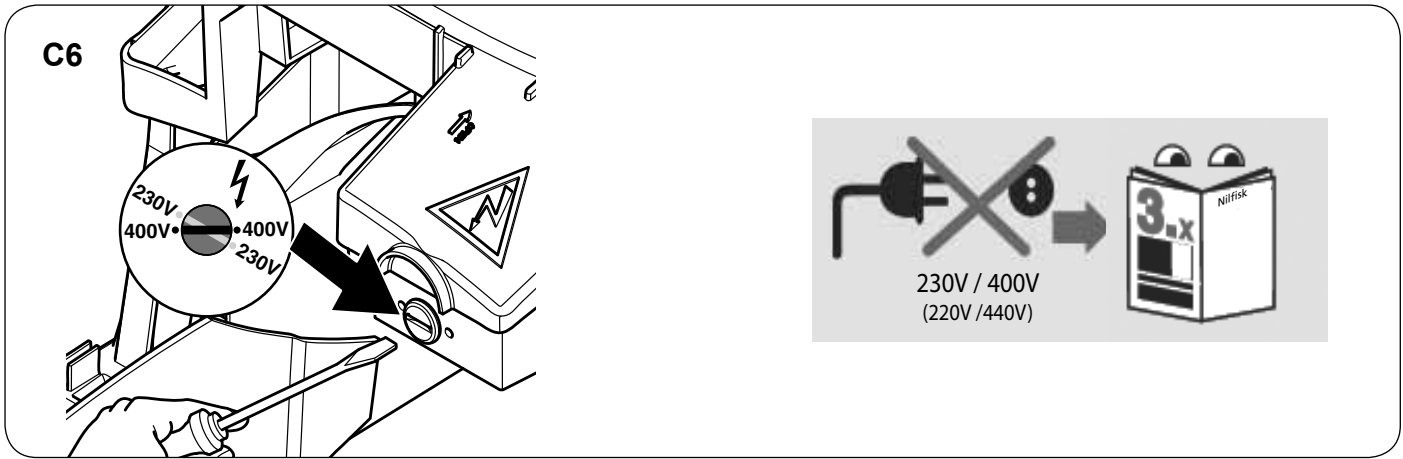

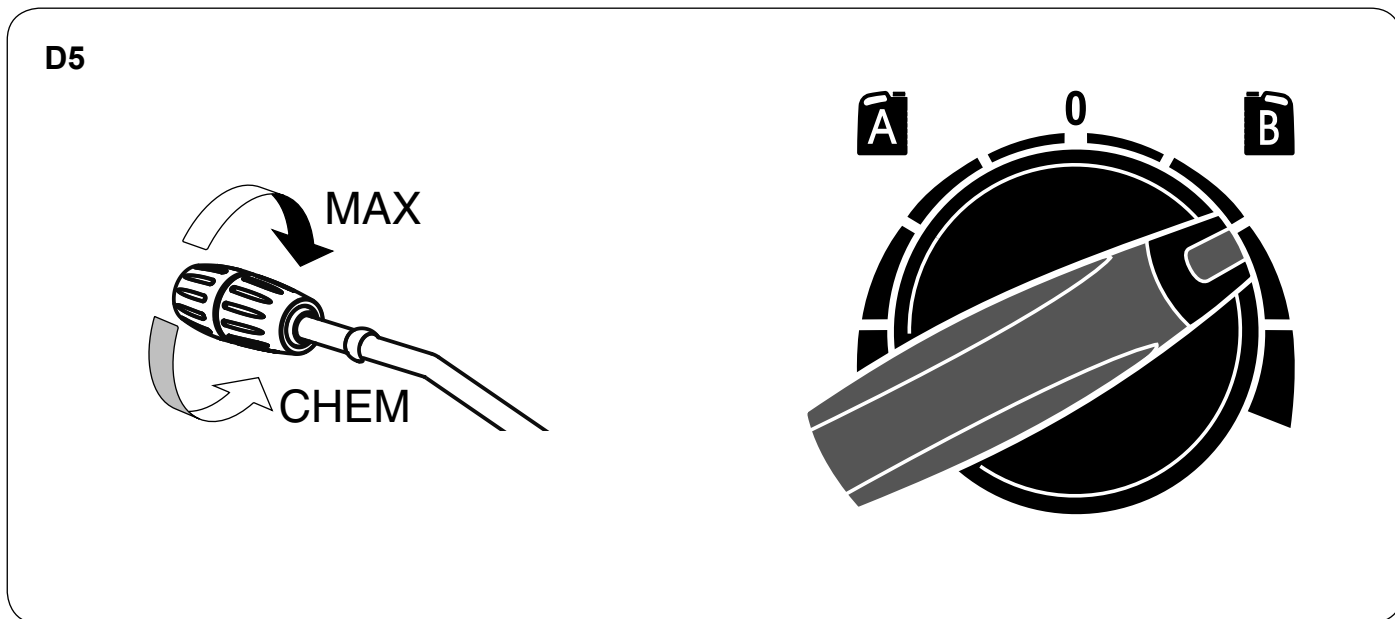
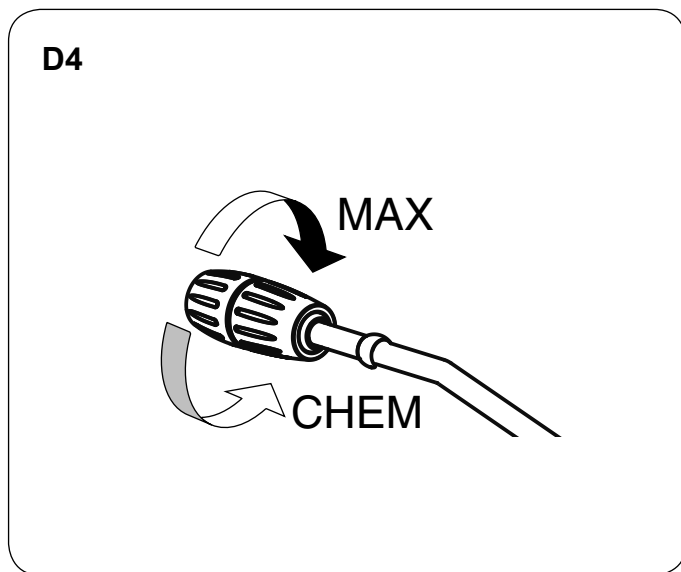
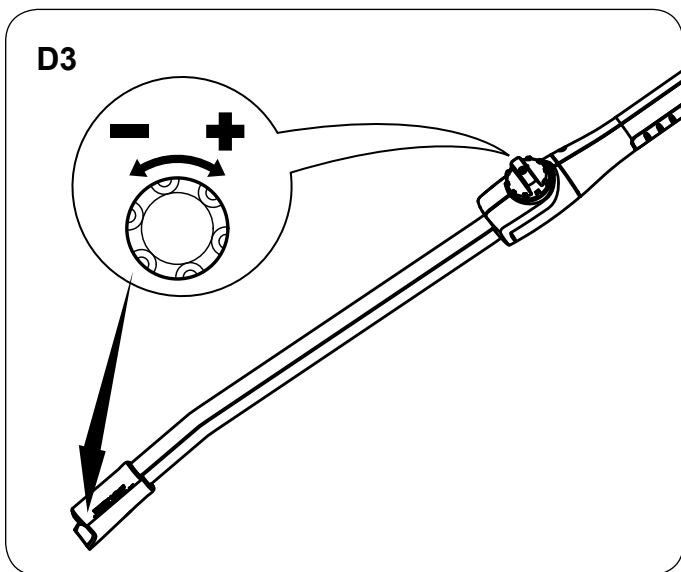
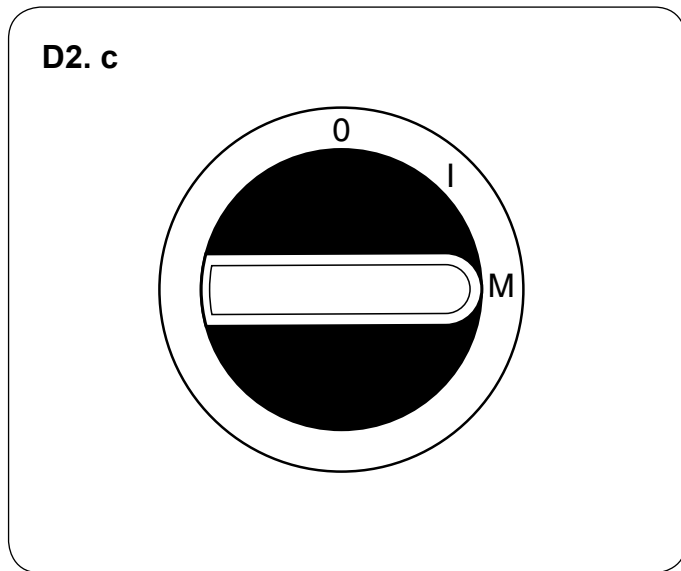
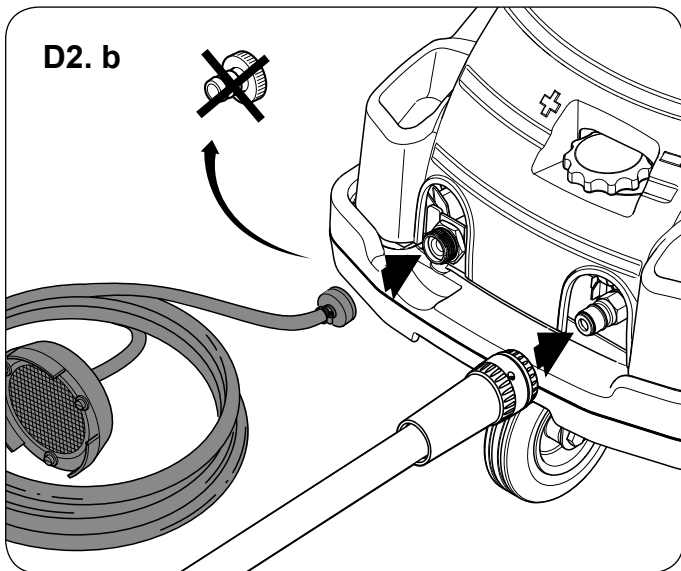

E1

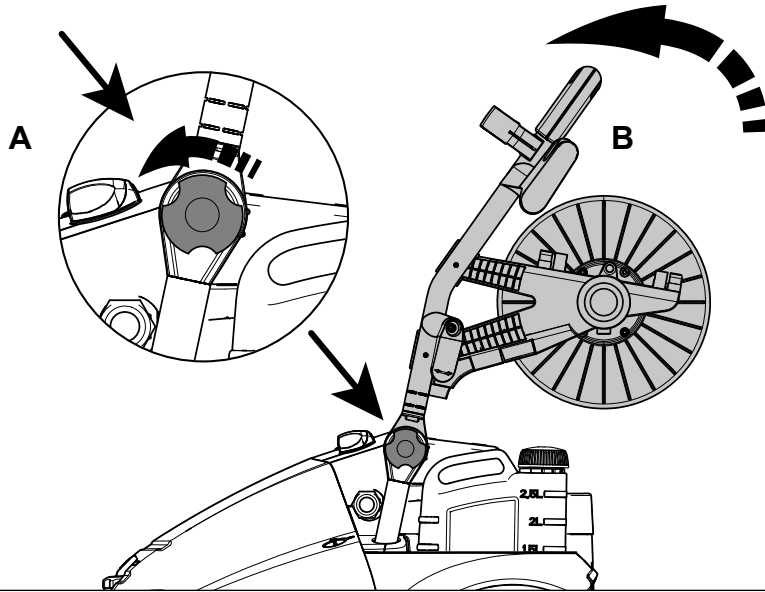

E2

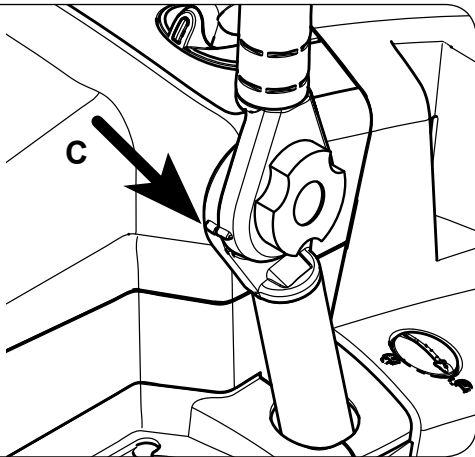

E3

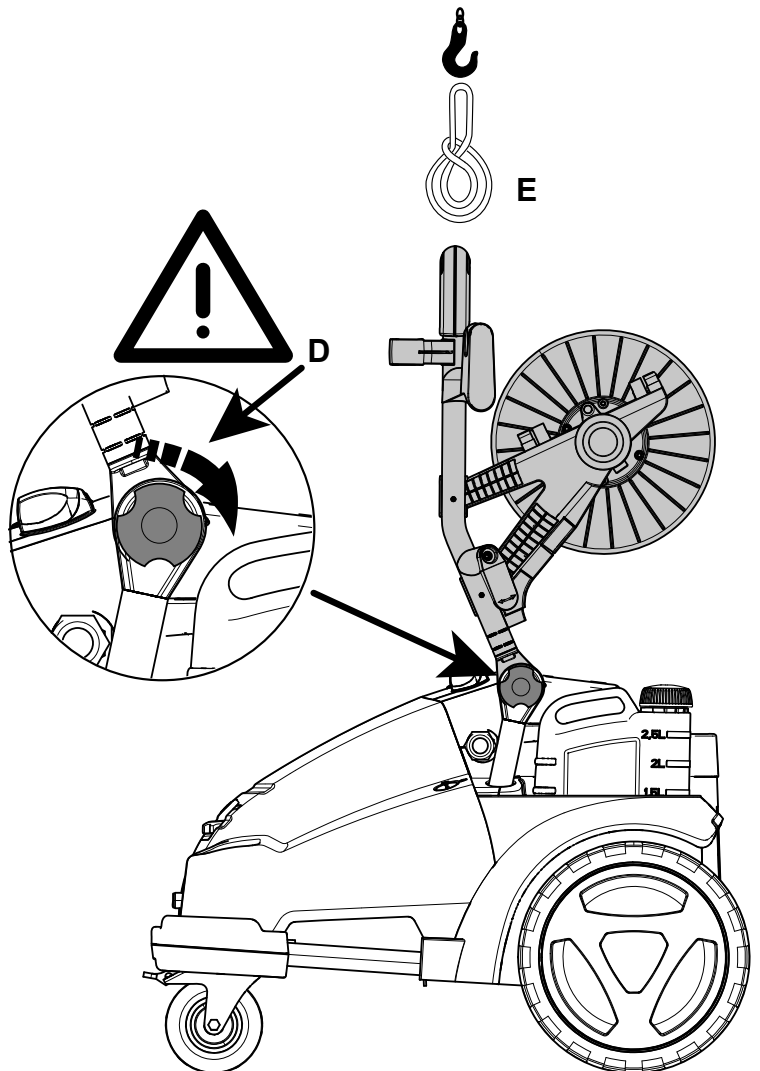

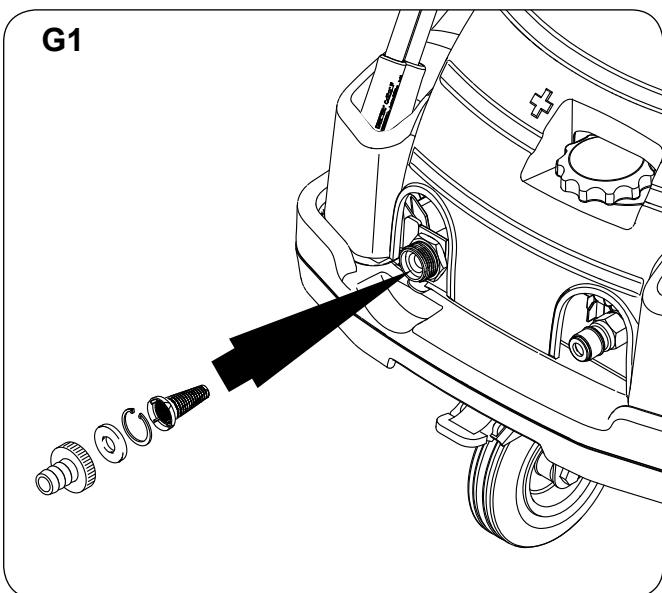
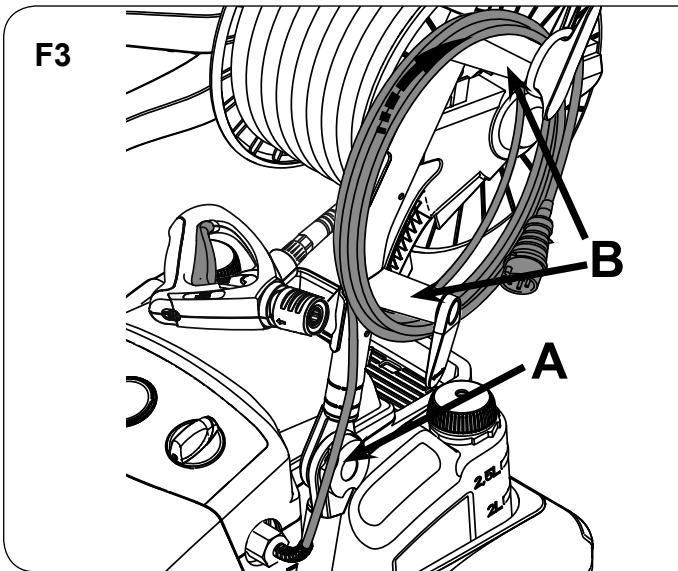
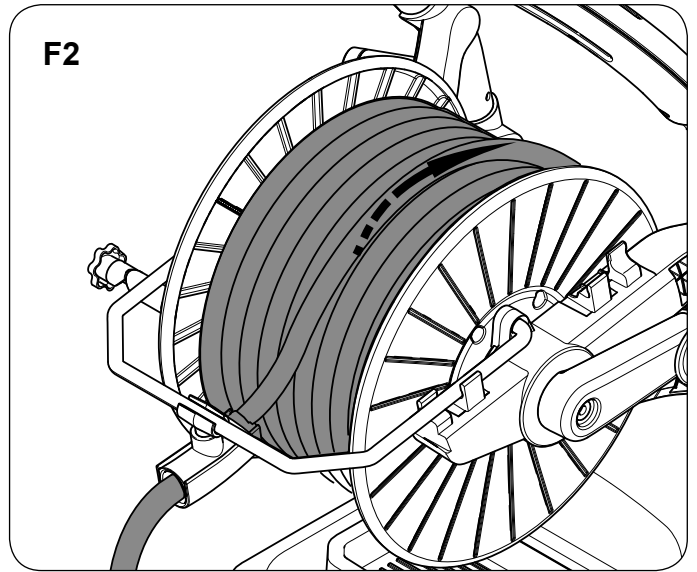
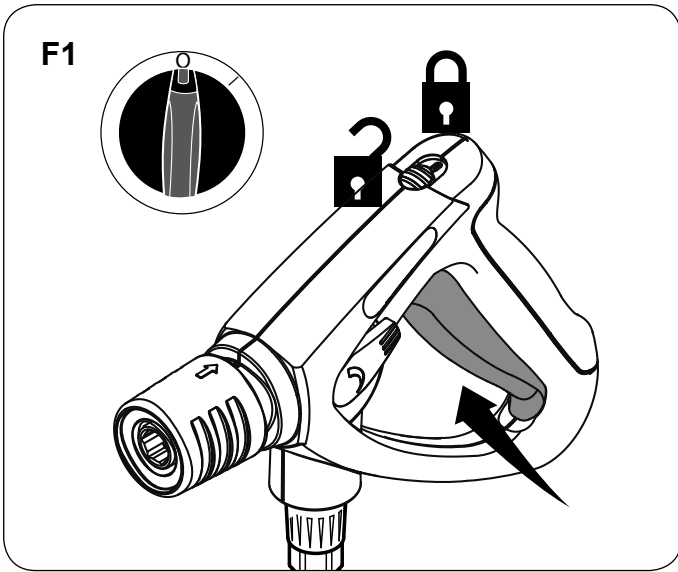

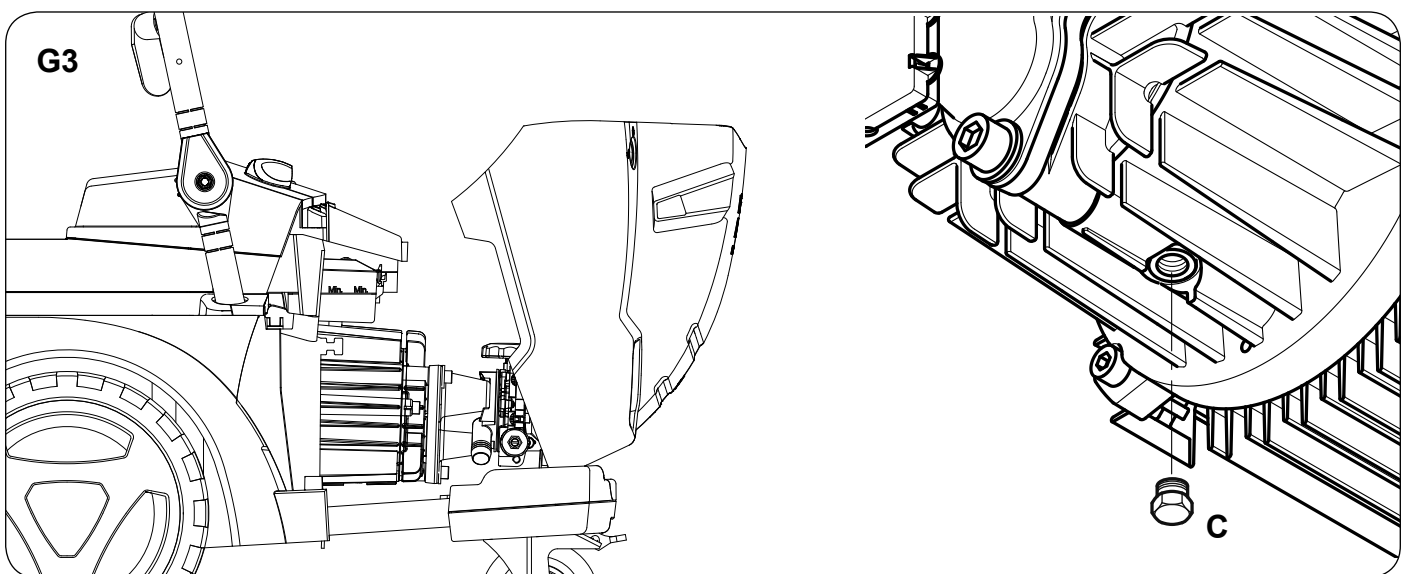
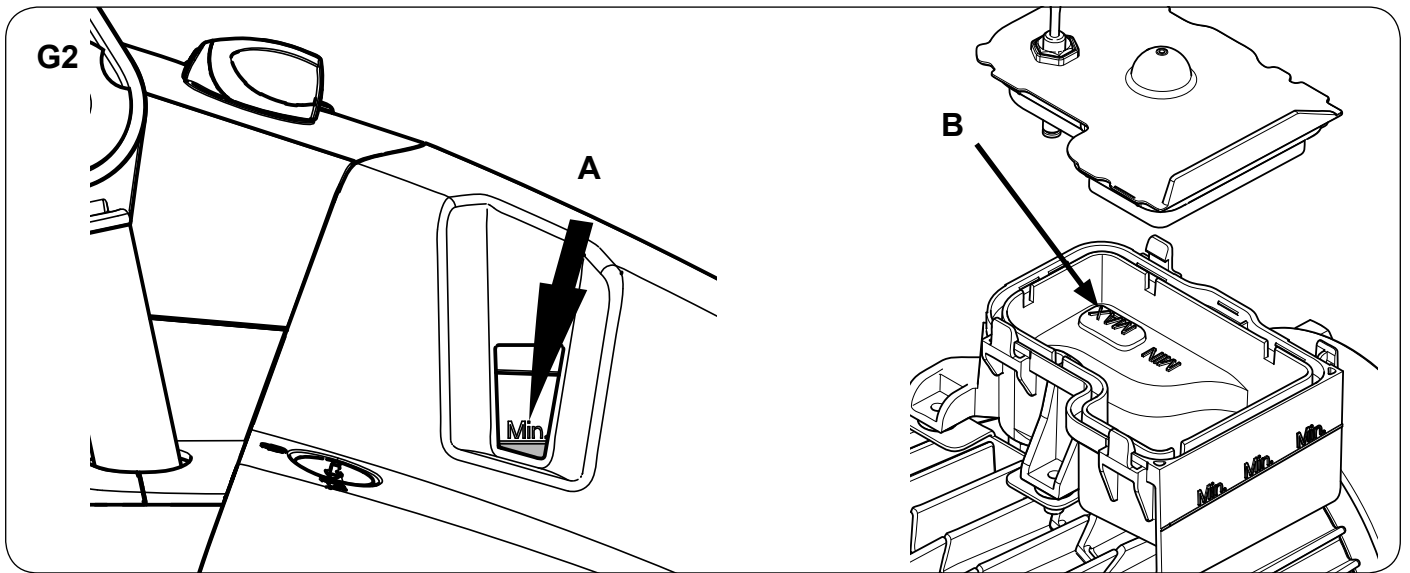

(EN)	Operating instructions	11
(DE)	Bedienungsanweisungen	15
(FR)	Instructions de fonctionnement	19
(NL)	Gebruiksaanwijzingen	23
(IT)	Istruzioni per l'uso	27
(NO)	Bruksanvisning	31
(SV)	Bruksanvisning	35
(DA)	Betjeningsvejledning	39
(FI)	Käyttöohje	43
(ES)	Instrucciones de funcionamiento	47
(PT)	Instruções de Funcionamento	51
(EL)	Οδηγίες λειτουργίας	55
(TR)	Kullanma Talimatları	59
(SL)	Navodila za delovanje	64
(HR)	Upute za uporabu	68
(SK)	Návod na obsluhu	72
(CS)	Návod k obsluze	76
(PL)	Instrukcje dotyczące obsługi	80
(HU)	Használati útmutató	84
(RO)	Instrucțiuni de utilizare.....	88
(BG)	Указания за експлоатация	92
(RU)	Руководство по эксплуатации	96
(ET)	Tööjuhised	100
(LV)	Norādījumi par ekspluatāciju	104
(LT)	Naudojimo instrukcija	108
(ZH)	操作说明.....	112
(KO)	사용법.....	116

Operating instructions

This high pressure washer has been designed for professional use typically in following cleaning applications:

Agriculture, industry, transport industry, automotive cleaning, municipal facilities, cleaning trade, construction industry, food industry etc.

The pictorial quick reference guide

The pictorial quick reference guide is designed for helping you when starting up, operating and storing the unit. The guide is subdivided into 8 sections.

A

DO READ SAFETY INSTRUCTIONS BEFORE USE!

Operating elements:

- A1. Push/pull handle
- A2. Spray gun¹⁾
- A3. Electrical lead
- A4. Holder for high pressure hose
- A5. High-pressure hose
- A6. Fastening screw
- A7. Lance¹⁾
- A8. Parking brake¹⁾
- A9. High-pressure hose connection (on standard models without hose reel¹⁾)
- A10. Water connection and water inlet filter
- A11. Oil inspection slide
- A12. Pressure gauge¹⁾
- A13. Main switch
- A14. Detergent dosing regulation¹⁾
- A15. Water flow regulation¹⁾
- A16. Detergent tank¹⁾
- A17. Cover lock

B

Before starting the cleaner

- B1. Before using the cleaner for the first time, check it carefully to detect any faults or damage. In the event of any damage contact your Nilfisk dealer immediately. Unfold and lock the handle in working position.

CAUTION!

Never lift the cleaner alone. Always ask a second person to help.

C

Setting up the unit

- C1. Check the oil level. On level ground, the oil should be above MIN level (A), when the oil is cold.
- C2. Fill up detergent tank¹⁾:
 - 1. Fill up detergent tank with prediluted Nilfisk detergent.
 - 2. Pull detergent hose and filter out of the storage and put it through the opening of the detergent tank filler cap.
- C3. Connecting the high pressure hose
 - a. Machines without high pressure hose reel: Put the quick connector of the high pressure hose onto the nipple on the cleaner.

NOTE! The maximum length of high pressure hose is 50 m.
 - b. Machines with high pressure hose reel:
 - 1. Put the quick connector of the high pressure hose (A) onto the nipple on the axle.

- 2. Put the high pressure hose into the hose guide (B) and fix it with the clip¹⁾.
- 3. Release the brake (C) on the hose reel guide¹⁾ and wind up the high pressure hose.

C4. Connecting the water supply:

- 1. Rinse the water supply hose briefly in order to prevent sand and other dirt particles entering into the machine.
- 2. Connect water supply hose to the machine.
- 3. Open water tap.

NOTE! In the case of poor water quality (sand, etc.), we recommend that a fine water filter is fitted to the machine. Max 50 Micron filter.

NOTE! We recommend the use of a textile-reinforced water hose with a nominal diameter of min. 3/4" (19 mm).

- C5. BA valve: This high pressure washer/cleaner is only allowed to be connected with the drinking water mains, when an appropriate backflow preventer has been installed, Type BA according to EN 60335-2-79.

The BA valve can be ordered under number (C: BA valve):

- BA valve including GARDENA couplings: 106411177
- BA valve including NITO couplings: 106411178
- BA valve including GEKA couplings: 106411179
- BA valve without couplings: 106411184

The couplings can be ordered under number (A: Female coupling, B: Male coupling):

- 3/4" GARDENA (A): 1608629
- 3/4" GARDENA (B): 32541
- 3/4" NITO (A): 1602945
- 3/4" NITO (B): 1600659
- 1/2" NITO (B): 1604669
- 3/4" GEKA (A): 1718
- 3/4" GEKA (B): 1311

Installation guide:

- 1. Mount a male coupling on the water tap.
- 2. Connect (A) on the BA valve to the water tap.
- 3. Mount a female coupling on the water inlet hose.
- 4. Connect (B) on the BA valve to the water inlet hose.
- 5. Connect the water inlet hose to the high pressure washer.
- 6. Turn on the water and start the machine.

CAUTION!

- The backflow preventer can be mounted either vertically or horizontally, and the drain opening (D) must be mounted pointing downwards.
- Water flowing from the drain opening (D) must be able to flow freely.
- If there is a risk of running sands in the inlet water (i.e. from your own well), an additional filter should be mounted between the water tap and backflow preventer.
- The length of the hose between the backflow preventer and the high pressure washer must be at least 12 metres (min diameter 3/4 inch) to absorb possible pressure peaks.
- As soon as water has flown through the BA valve, this water is not considered to be drinking water any more.
- Protect the backflow preventer against any exposure to frost.
- Keep the backflow preventer clean, and free of dirt.

Maintenance

At least once a year, check the function as follows:

1. After work, switch off the high pressure cleaner.
2. Close the water tap valve.
3. Release the pressure in the water supply hose by triggering the spray pistol.
4. Dismount the backflow preventer. Water has to come out of the drain opening (D) (max. 100ml) to ensure separation of the potable water.
5. If this is not the case, try cleaning the BA valve or contact your Nilfisk representative.

C6. Electrical connection

1. Observe safety instructions.
2. Put the plug into the electrical socket.

CAUTION!

- Before connecting devices with voltage changeover: Check that the pre-selected voltage on the machine corresponds with the voltage of the electrical installation. Otherwise the electrical devices of the machine can be destroyed¹⁾.

- When using a cord reel: Unwind the cord completely.
- The cleaner may only be connected to a correctly installed electrical installation.

C7. Releasing the cable

1. Turn the cable hook (A).
2. Release the cable (B).
3. Turn back the cable hook.

D

Switching on the unit

D1. Connecting the spray lance to the spray gun.

1. Pull back the blue quick-release grip (A) of the spray gun.
2. Insert the nipple of the spray lance (B) into the quick-release connection and release the coupling (A).
3. Pull the spray lance (or other accessory) forwards to check that it is securely attached to the spray gun.
NOTE! Always remove any dirt from the nipple before connecting the spray lance to the spray gun.
NOTE! Ambient temperature should be above 0°C and not higher than 40°C. Machine temperature must not be below 0°C.

D2.a Switching on the cleaner when it is connected to a water supply:

1. Main switch: Turn the switch to position "I".
2. Unlock the spray gun and operate it.
3. Lock the spray gun even during short pauses.
NOTE! Operate the spray gun several times at short intervals to vent the system. The cleaner switches off automatically after the spray gun has been closed. To start the cleaner again, operate the spray gun. DSS-models switch off with a delay of 20 seconds¹⁾.

D2.b Switching on the cleaner when it is connected to open tanks in suction mode¹⁾ (Pressure activated model):

1. Before connecting the suction set: 61256 to the cleaner, fill the hose with water.
2. Turn the main switch to position "I".
3. Unlock the spray gun and operate it.

D2.c Switching on the cleaner when it is connected to open tanks in suction mode¹⁾ (Flow activated model):

1. Before connecting the suction set: 61256 to the cleaner, fill the hose with water.
2. Turn the main switch to position "M".
3. Unlock the spray gun and operate it.

4. To start the cleaner again, operate the main switch again.

NOTE! The cleaner automatically switches off after more than 5 minutes of inactivity. See specification for max. suction height.

D3. Pressure regulation with Tornado Plus lance and Power-SpeedVario Plus lance:

High pressure = clockwise (+)

Low pressure = anticlockwise (-)

D4. Pressure regulation with the FlexoPowerPlus nozzle head and the PowerSpeedVario Plus lance: Twist cap of the FlexoPowerPlus nozzle head:

High pressure = MAX.

Low pressure = MIN.(CHEM)

D5. Using cleaning agents: Cleaning agent can be drawn in via the injector installed as standard only in low-pressure mode:

1. Dilute cleaning agent according to the manufacturer's instructions.

2. Tornado Plus lance and PowerSpeedVario Plus lance¹⁾: Set pressure regulation on spray lance to low pressure (-), or FlexoPowerPlus nozzle head¹⁾:

Turn cap of the FlexoPowerPlus nozzle head towards "CHEM" up to the stop.

3. The intaken volume of cleaning agent can be regulated by turning the metering valve.

4. Select tank A by turning the metering valve on "A-side". Select tank B by turning the metering valve on "B-side"

5. Main switch: Turn the switch to position "I".

6. Operate the spray gun.

NOTE! Never allow cleaning agent to dry on the surface to be cleaned. The surface may be damaged.

E

Lifting with crane

- E1. Before crane lifting the machine should be in balance. Loosen the screw (A), push the handle (B) a little forward.
- E2. When the two marks are aligned (C), the handle is in crane-lifting position.
- E3. Be careful to fasten the screw (D) in the lifting position. Wrap a belt strop around center of the handle (E) for the crane to hook in.
WARNING! Do not stand under the machine hanging in the air.

F

After using the unit or before leaving it unattended

- F1. Switch off the cleaner:
 1. Turn the main switch to position "OFF".
 2. Close water tap.
 3. Squeeze the spray gun handle until the cleaner is depressurised.
 4. Lock the safety catch on the spray gun.
 5. Remove the water hose from the cleaner.
 6. Pull out the plug from the electrical socket.
- F2. Rolling up the hose and storing of lance. To prevent accidents, always carefully roll up the hose.
 1. Wind up the hose as illustrated.
 2. Place the spray lance into the spray lance storage.
- F3. Winding up the cable
 1. Winding up the cable from front over the fastening screw (A) and clock-wise around the cable hooks (B).
 2. At last turn, lock the cable end in the cable lock (C).

G

Maintenance

- G1. Cleaning water inlet filter. A water filter is fitted on the water inlet to prevent large particles of dirt from entering into the pump.
 1. Unscrew the quick-release connection if mounted.
 2. Remove the filter and rinse it. Replace damaged filter.
- G2. Checking the pump oil level.
 1. Check the oil level. On level ground, the oil should be above MIN. level (A), when the oil is cold.
 2. If necessary, add oil. Fill to MAX level (B).
- G3. Changing the pump oil
 1. Before changing the oil, allow the cleaner to become warm.
 2. Remove cabinet.
 3. Loosen and remove drain plug (C). The plug magnet has to be cleaned with a piece of cloth/napkin to remove metal particles. Drain the oil into a suitable container (min. 1 litre) and dispose the oil in compliance with regulations.
 4. Fit drain plug and refill with oil according to specification.
 5. Oil should be over the MIN. level in the oil container at level ground. Fill to MAX (B).
 6. Fit the cabinet again.
- G4. Check the pump oil quality: Check colour of pump oil. If the oil has a white shade, contact Nilfisk service!
 NOTE! Special pump oil is required if the cleaner is used near food. Please consult your Nilfisk dealer.

- 8. Lift the suction hose from the tank containing anti-freeze and operate the spray gun to pump off the remaining antifreeze.
- 9. Switching off the cleaner
- 10. To avoid any risks, store the cleaner temporarily in a heated room before using it again.

Further information

Recycling the cleaner:

Make the old cleaner unusable immediately. Unplug the cleaner and cut the power cord. Do not discard electrical appliances with household waste.

Guarantee:

Our general conditions of business are applicable with regard to the guarantee. Subject to change as a result of technical advances.

Maintenance plan

	Weekly	Every 500 operating hours	As required
Cleaning water inlet filter			●
Grease quick coupling nipples for hose, spray handle and lance	●		
Checking pump oil level	●		
Changing pump oil		●	
Check the pump oil quality	●		

H

Storing the cleaner (below 0°C)

- Store the cleaner in a dry room without danger of frost or protect as below:
 If the high-pressure cleaner is stored in a room with temperatures around or below 0°C, anti-freeze should be drawn into the pump beforehand:
1. Remove the water inlet hose from the cleaner.
 2. Remove the spray lance.
 3. Switch on the cleaner with the main switch in position "I" and activate trigger on the spray gun.
 Switch off the cleaner after max. 3 minutes.
 4. Connect the suction hose to the water inlet of the cleaner and place it in a tank containing anti-freeze.
 5. Switch on the cleaner with the main switch in position "I".
 6. Hold the spray gun over the tank containing anti-freeze and operate it to start suction.
 7. During suction operate the spray gun two or three times.

Troubleshooting

Fault	Cause	Remedy
Pressure drop	<ul style="list-style-type: none"> • Air in the system • High pressure nozzle blocked worn • Detergent tank empty 	<ul style="list-style-type: none"> • Vent the system by operating the spray gun several times at short intervals. If necessary, operate the cleaner for a short time without the high-pressure hose connected. • Clean/replace the high pressure nozzle • Top up detergent tank or set detergent to "0"
Pressure fluctuations	<ul style="list-style-type: none"> • Pump draws in air (only possible in suction mode) • Lack of water • Water inlet hose is too long or its cross-section too small • Lack of water caused by blocked water filter • Lack of water because max. permissible suction height has not been heeded 	<ul style="list-style-type: none"> • Check that the suction set is air-tight • Open water tap • Use a water inlet hose that can provide the water flow (Q_{max}) defined for the machine • Clean the water filter in the water connection (never work without water filter) • See instructions
The motor does not start when the cleaner is switched on	<ul style="list-style-type: none"> • The plug is not inserted properly, i.e. there is no current • Oil level too low • The mains fuse is switched off • The overload protection has been activated due to overheating or overloading of the motor 	<ul style="list-style-type: none"> • Check the plug, lead and switch and if necessary have them replaced by a skilled electrician • Check oil/add oil • Switch on the mains fuse • Check that the mains voltage and the cleaner voltage are the same. Switch off the cleaner and allow it to cool for at least 3 minutes
When the cleaner is switched on the motor buzzes without starting	<ul style="list-style-type: none"> • The mains voltage is too low or there is a phase failure. • The pump is blocked or frozen • Incorrect cross-section or length of the extension lead 	<ul style="list-style-type: none"> • Have the electrical connection checked • Contact the Nilfisk customer service • Use lead with correct cross section or length
The motor switches off	<ul style="list-style-type: none"> • The overload protection has been activated due to overheating or overloading of the motor • High-pressure nozzle is dirty 	<ul style="list-style-type: none"> • Check that the mains voltage and the cleaner voltage are the same. Switch off the cleaner and allow it to cool for at least 3 minutes • Change the high-pressure nozzle
No detergents drawn in	<ul style="list-style-type: none"> • Detergent tank empty • The cap on the FlexoPower-Plus nozzle head is not set to low pressure • Double lance are not adjusted to low pressure. • Injector is dirty or suction hose is blocked. 	<ul style="list-style-type: none"> • Top up detergent tank • Set to low pressure • Set to low pressure • Clean

Declaration of Conformity

Prohlášení o shodě
 Konformitätserklärung
 Overensstemmelseserklæring
 Declaración de conformidad
 Vastavusdeklaratsioon
 Déclaration de conformité
 Vaatimustenmukaisuusvakuutus

Декларация за съответствие
 Δήλωση συμμόρφωσης
 Megfelelősségi nyilatkozat
 Izjava o skladnosti
 Dichiarazione di conformità
 Atitikties deklaracija
 Atbilstības deklarācija
 Samsvarserklæring
 Conformiteitsverklaring

Declaração de conformidade
 Deklaracja zgodności
 Declaratie de conformitate
 Декларация о соответствии
 Försäkran om överensstämmelse
 Vyhlášení o zhode
 Izjava o skladnosti
 Uygunluk beyanı

Manufacturer / Výrobce / Hersteller / Fabrikant /
 Fabricante / Κατασκευαστής / Gyártó / Proizvođač /
 Fabbicante / Gamintojas / Ražotājs / Producent /
 Fabrikant / Fabricante / Producent / Producător /
 производитель / Tillverkaren / Výrobca / Proizvajalec /
 Üretici firma:

**Nilfisk A/S, Kornmarksvej 1
 DK-2605 Broendby, DENMARK**

Product / Produkt / Producto, Toode, Produit, Tuote /
 Продукт / Προϊόν / Termék / Proizvod / Prodotto /
 Produktas / Produkts / Artikel / Produtos / Produis /
 Izdelek / Ürün

MC 5M, -6P, -7P

Description / Popis / Beschreibung / Beskrivelse /
 Descripción / Kirjeldus / La description / Kuvaus /
 Описание / Περιγραφή / Leirás / Opis / Descrizione /
 Aprašymas / Apraksts / Beschrijving / Descrição /
 Descriere / Beskrivning / Popis / Açıklama

**HPW - Professional - Mobile - EI
 230V 1~, 230/400V, 400V 3~, 50Hz, IPX5**

EN

**We, Nilfisk hereby declare under our sole
 responsibility, that the above-mentioned
 product(s) is/are in conformity with the
 following directives and standards.**

LT

Mes, „Nilfisk“, prisiimdami visišką
 atsakomybę pareiškiame, kad pirmiau
 minėtas produktas (-ai) atitinka šias
 direktyvas ir standartus

CS

My, Nilfisk prohlašujeme na svou výlučnou
 odpovědnost, že výše uvedený výrobek je ve
 shodě s následujícími směrnici a normami.

LV

Mēs, Nilfisk, ar pilnu atbildību apliecinām, ka
 iepriekšminētais produkts atbilst šādām
 direktīvām un standartiem

DE

Wir, Nilfisk erklären in alleiniger
 Verantwortung, dass das oben genannte
 Produkt den folgenden Richtlinien und
 Normen entspricht.

NO

Vi, Nilfisk erklærer herved under eget ansvar,
 at det ovennevnte produktet er i samsvar
 med følgende direktiver og standarder

DA

Vi, Nilfisk erklærer hermed under eget ansvar
 at ovennævnte produkt(er) er i
 overensstemmelse med følgende direktiver og
 standarder.

NL

We verklaren Nilfisk hierbij op eigen
 verantwoordelijkheid, dat het
 bovengenoemde product voldoet aan de
 volgende richtlijnen en normen

ES

Nosotros, Nilfisk declaramos bajo nuestra
 única responsabilidad que el producto antes
 mencionado está en conformidad con las
 siguientes directivas y normas

PT

Nós, a Nilfisk declaramos, sob nossa exclusiva
 responsabilidade, que o produto acima
 mencionado está em conformidade com as
 diretrizes e normas a seguir

ET

Meie, Nilfisk Käesolevaga kinnitame ja
 kanname ainuisikulist vastutust, et eespool
 nimetatud toode on kooskõlas järgmiste
 direktiivide ja

PL

My, Nilfisk Niniejszym oświadczamy z pełną
 odpowiedzialnością, że wyżej wymieniony
 produkt jest zgodny z następującymi
 dyrektywami i normami..



Nilfisk déclare sous notre seule responsabilité que le produit mentionné ci-dessus est conforme aux directives et normes suivantes.



Me, Nilfisk täten vakuutamme omalla vastuulla, että edellä mainittu tuote on yhdenmukainen seuraavien direktiivien ja standardien mukaisesti



Ние, Nilfisk С настоящото декларираме на своя лична отговорност, че посочените по-горе продуктът е в съответствие със следните директиви и стандарти.



Εμείς, Nilfisk δηλώνουμε με αποκλειστική μας ευθύνη, ότι το προαναφερόμενο προϊόν συμμορφώνεται με τις ακόλουθες οδηγίες και πρότυπα.



Mi, Nilfisk Kijelentjük, egyedüli felelősséggel, hogy a fent említett termék megfelel az alábbi irányelveknek és szabványoknak



Mi, Nilfisk Izjavljujemo pod punom odgovornošću, da gore navedeni proizvod u skladu sa sljedećim direktivama i standardima.



Noi, Nilfisk dichiara sotto la propria responsabilità, che il prodotto di cui sopra è conforme alle seguenti direttive e norme.



Noi, Nilfisk Prin prezenta declarăm pe propria răspundere, că produsul mai sus menționat este în conformitate cu următoarele standarde și directive



Мы, Nilfisk настоящим заявляем под нашу полную ответственность, что вышеперечисленные продукция соответствует следующими директивам и стандартам.



Vi Nilfisk förklarar härmed under eget ansvar att ovan nämnda produkt överensstämmer med följande direktiv och normer.



My, Nilfisk prehlasujeme na svoju výlučnú zodpovednosť, že vyššie uvedený výrobok je v zhode s nasledujúcimi smernicami a normami.



Mi, Nilfisk izjavljamo s polno odgovornostjo, da je zgoraj omenjeni izdelek v skladu z naslednjimi smernicami in standardi.



Nilfisk, burada yer alan tüm sorumluluklarımıza göre, yukarıda belirtilen ürünün aşağıdaki direktifler ve standartlara uygun olduğunu beyan ederiz.













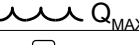
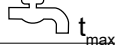
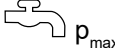
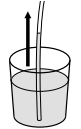

2006/42/EC	EN 60335-1:2012+A11:2014+A13:2017 EN 60335-2-79:2012
2014/30/EU	EN 55014-1:2017+A11:2020 EN 55014-2:2015 EN 61000-3-2:2014 EN 61000-3-11:2000
2011/65/EU	EN 63000:2018
2000/14/EC – Conformity assessment procedure according to Annex V.	- Measured sound power level: 82-93 dB(A); Guaranteed sound power level: 85-96 dB(A)

Authorized signatory:













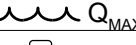
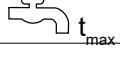
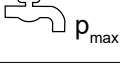
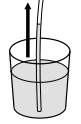

Pierre Mikaelsson, Executive Vice President, Global Products & Services, Nilfisk NLT

Oct 14, 2020















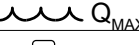

Specifications

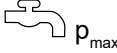
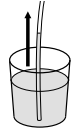
			5M-180/840	5M-180/840 XT	5M-200/1000	5M-200/1000 XT
1			EU	EU	EU	EU
2		V/ph/Hz	400/3/50	400/3/50	400/3/50	400/3/50
3		A	16	16	16	16
4		kW кВт	4,8	4,8	6,1	6,1
5		bar (MPa) Бар (МПа) 巴 (兆帕)	180 (18)	180 (18)	200 (20)	200 (20)
6		l/h л/час 升/小时	760	760	940	940
7		bar (MPa) Бар (МПа) 巴 (兆帕)	250 (25)	250 (25)	250 (25)	250 (25)
8		l/h	840	840	1000	1000
9		°C (°F)	60 (140)	60 (140)	60 (140)	60 (140)
10		bar (MPa) Бар (МПа) 巴 (兆帕)	10 (1)	10 (1)	10 (1)	10 (1)
11		m 米	1	1	1	1
12		mm 毫米	735x570x1020	890x570x1020	735x570x1020	890x570x1020
13		kg кг	66	72	71	76
14	 $K_{PA} = 3 \text{ dB}$	dB(A) дБ(A)	75	75	76	76
15	 $K_{WA} = 3 \text{ dB}$	dB(A) дБ(A)	88	88	89	89
16	 (ISO 5349 a_h)	m/s ² 米/秒 ²	≤ 2,5	≤ 2,5	≤ 2,5	≤ 2,5
17		N	34,4	34,9	44,7	45,4
18		l 升	0,73	0,73	0,73	0,73
19			Castrol Alphasyn 150	Castrol Alphasyn 150	Castrol Alphasyn 150	Castrol Alphasyn 150













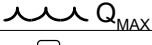
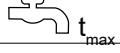
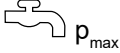
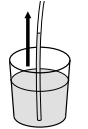

Specifications

			5M-200/1050 FA	5M-200/1050	5M-200/1050 XT	5M-220/1130 FA
1			EU	EU	EU	EU
2		V/ph/Hz	400/3/50	400/3/50	400/3/50	400/3/50
3		A	16	16	16	16
4		kW кВт	6,1	6,1	6,1	7,4
5		bar (MPa) Бар (МПа) 巴 (兆帕)	200 (20)	200 (20)	200 (20)	220 (22)
6		l/h л/час 升/小时	960	960	960	1040
7		bar (MPa) Бар (МПа) 巴 (兆帕)	250 (25)	250 (25)	250 (25)	250 (25)
8		l/h	1050	1050	1050	1130
9		°C (°F)	60 (140)	60 (140)	60 (140)	60 (140)
10		bar (MPa) Бар (МПа) 巴 (兆帕)	10 (1)	10 (1)	10 (1)	10 (1)
11		m 米	1	1	1	1
12		mm 毫米	735x570x1020	735x570x1020	890x570x1020	735x570x1020
13		kg кг	73	73	78	79
14	 $K_{PA} = 3 \text{ dB}$	dB(A) дБ(A)	76	76	76	75
15	 $K_{WA} = 3 \text{ dB}$	dB(A) дБ(A)	89	89	89	88
16	 (ISO 5349 a_h)	m/s ² 米/秒 ²	≤ 2,5	≤ 2,5	≤ 2,5	≤ 2,5
17		N	46	46	46,5	52,8
18		l 升	0,73	0,73	0,73	0,73
19			Castrol Alphasyn 150	Castrol Alphasyn 150	Castrol Alphasyn 150	Castrol Alphasyn 150













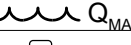
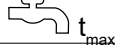
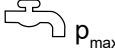
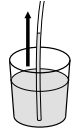

Specifications

			5M-220/1130	5M-220/1130 XT	5M-200/1050	5M-200/1050 XT
1			EU	EU	NO,BE	NO,BE
2		V/ph/Hz	400/3/50	400/3/50	230-400/ 3/50	230-400/ 3/50
3		A	16	16	25	25
4		kW кВт	7,4	7,4	6,1	6,1
5		bar (MPa) Бар (МПа) 巴 (兆帕)	220 (22)	220 (22)	200 (20)	200 (20)
6		l/h л/час 升/小时	1040	1040	960	960
7		bar (MPa) Бар (МПа) 巴 (兆帕)	250 (25)	250 (25)	250 (25)	250 (25)
8		l/h	1130	1130	1050	1050
9		°C (°F)	60 (140)	60 (140)	60 (140)	60 (140)
10		bar (MPa) Бар (МПа) 巴 (兆帕)	10 (1)	10 (1)	10 (1)	10 (1)
11		m 米	1	1	1	1
12		mm 毫米	735x570x1020	890x570x1020	735x570x1020	890x570x1020
13		kg кг	78	85	75	80
14	 $K_{PA} = 3 \text{ dB}$	dB(A) дБ(A)	75	75	76	76
15	 $K_{WA} = 3 \text{ dB}$	dB(A) дБ(A)	88	88	89	89
16	 (ISO 5349 a_h)	m/s ² 米/秒 ²	≤ 2,5	≤ 2,5	≤ 2,5	≤ 2,5
17		N	52,8	54	46	46,5
18		l 升	0,73	0,73	0,73	0,73
19			Castrol Alphasyn 150	Castrol Alphasyn 150	Castrol Alphasyn 150	Castrol Alphasyn 150



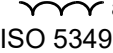









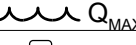
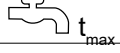
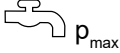
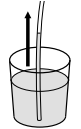

Specifications

			5M-100/770	5M-100/770 XT	5M-200/1050	5M-220/1130
1			UK	UK	EXP	EXP
2		V/ph/Hz	230/1/50	230/1/50	220-440/ 3/60	220-440/ 3/60
3		A	13	13	20	30
4		kW кВт	2,9	2,9	6,1	7
5		bar (MPa) Бар (МПа) 巴 (兆帕)	100 (10)	100 (10)	200 (20)	220 (22)
6		l/h л/час 升/小时	700	700	960	1040
7		bar (MPa) Бар (МПа) 巴 (兆帕)	150 (15)	150 (15)	250 (25)	250 (25)
8		l/h	770	770	1050	1130
9		°C (°F)	60 (140)	60 (140)	60 (140)	60 (140)
10		bar (MPa) Бар (МПа) 巴 (兆帕)	10 (1)	10 (1)	10 (1)	10 (1)
11		m 米	1	1	1	1
12		mm 毫米	735x570x1020	890x570x1020	735x570x1020	735x570x1020
13		kg кг	68	73	74	80
14	 $K_{PA} = 3 \text{ dB}$	dB(A) дБ(A)	68	68	76	75
15	 $K_{WA} = 3 \text{ dB}$	dB(A) дБ(A)	82	82	89	88
16	 (ISO 5349 a_h)	m/s ² 米/秒 ²	≤ 2,5	≤ 2,5	≤ 2,5	≤ 2,5
17		N	23,5	23,7	45,6	52,8
18		l 升	0,73	0,73	0,73	0,73
19			Castrol Alphasyn 150	Castrol Alphasyn 150	Castrol Alphasyn 150	Castrol Alphasyn 150













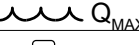
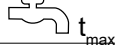
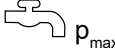
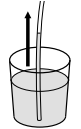

Specifications

			5M-115/700	5M-200/1030	6P-250/1100 FA	6P-250/1100 FA
1			AU	AU	EU	EXP
2		V/ph/Hz	240/1/50	415/3/50	400/3/50	220-440/ 3/60
3		A	15	20	16	30
4		kW кВт	3	6,1	8,5	8,5
5		bar (MPa) Бар (МПа) 巴 (兆帕)	115(11,5)	200(20)	250 (25)	250 (25)
6		l/h л/час 升/小时	630	950	1000	1000
7		bar (MPa) Бар (МПа) 巴 (兆帕)	172,5(17,25)	250(25)	250 (25)	250 (25)
8		l/h	700	1030	1100	1100
9		°C (°F)	60(140)	60(140)	80 (176)	80 (176)
10		bar (MPa) Бар (МПа) 巴 (兆帕)	10 (1)	10 (1)	10 (1)	10 (1)
11		m 米	1	1	1	1
12		mm 毫米	735x570x1020	735x570x1020	775x570x1020	775x570x1020
13		kg кг	68	73	89	89
14	 $K_{PA} = 3 \text{ dB}$	dB(A) дБ(A)	68	76	80	80
15	 $K_{WA} = 3 \text{ dB}$	dB(A) дБ(A)	82	89	93	93
16	 (ISO 5349 a_h)	m/s ² 米/秒 ²	≤ 2,5	≤ 2,5	≤ 2,5	≤ 2,5
17		N	22,8	46,4	54,1	57,2
18		l 升	0,73	0,73	0,95	0,95
19			Castrol Alphasyn T 150	Castrol Alphasyn T 150	Castrol Alphasyn 150	Castrol Alphasyn 150













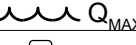
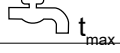
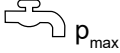
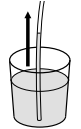

Specifications

			6P-180/1300 FA	6P-180/1300 FA	6P-170/1600 FA	6P-250/1100 FAXT
1			EU	EXP	EU	EU
2		V/ph/Hz	400/3/50	220-440/ 3/60	400/3/50	400/3/50
3		A	16	30	16	16
4		kW кВт	7,4	8,2	8,8	8,8
5		bar (MPa) Бар (МПа) 巴 (兆帕)	180 (18)	180 (18)	170 (17)	250 (25)
6		l/h л/час 升/小时	1200	1200	1500	1000
7		bar (MPa) Бар (МПа) 巴 (兆帕)	250 (25)	250 (25)	250 (25)	250 (25)
8		l/h	1300	1300	1600	1100
9		°C (°F)	80 (176)	80 (176)	80 (176)	80 (176)
10		bar (MPa) Бар (МПа) 巴 (兆帕)	10 (1)	10 (1)	10 (1)	10 (1)
11		m 米	1	1	1	1
12		mm 毫米	775x570x1020	775x570x1020	775x570x1020	930x570x1020
13		kg кг	86	87	89	96
14	 $K_{PA} = 3 \text{ dB}$	dB(A) дБ(A)	77	77	77	80
15	 $K_{WA} = 3 \text{ dB}$	dB(A) дБ(A)	90	90	90	93
16	 (ISO 5349 a_h)	m/s ² 米/秒 ²	≤ 2,5	≤ 2,5	≤ 2,5	≤ 2,5
17		N	56,4	58	68,2	54,6
18		l 升	0,95	0,95	0,95	0,95
19			Castrol Alphasyn 150	Castrol Alphasyn 150	Castrol Alphasyn 150	Castrol Alphasyn 150













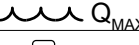
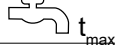
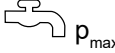
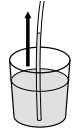

Specifications

			6P-180/1300 FAXT	6P-180/1300 FAXT	6P-170/1600 FAXT	6P-200/1100 FAXT
1			EU	NO, BE	EU	EU
2		V/ph/Hz	400/3/50	230-400/3/50	400/3/50	400/3/50
3		A	16	25	16	16
4		kW кВт	7,7	7,7	9	7,3
5		bar (MPa) Бар (МПа) 巴 (兆帕)	180 (18)	180 (18)	170 (17)	200 (20)
6		l/h л/час 升/小时	1200	1200	1500	1000
7		bar (MPa) Бар (МПа) 巴 (兆帕)	250 (25)	250 (25)	250 (25)	250 (25)
8		l/h	1300	1300	1600	1100
9		°C (°F)	80 (176)	80 (176)	80 (176)	80 (176)
10		bar (MPa) Бар (МПа) 巴 (兆帕)	10 (1)	10 (1)	10 (1)	10 (1)
11		m 米	1	1	1	1
12		mm 毫米	930x570x1020	930x570x1020	930x570x1020	930x570x1020
13		kg кг	93	93	96	85
14	 $K_{PA} = 3 \text{ dB}$	dB(A) дБ(A)	77	77	77	75
15	 $K_{WA} = 3 \text{ dB}$	dB(A) дБ(A)	90	90	90	88
16	 (ISO 5349 a_h)	m/s ² 米/秒 ²	≤ 2,5	≤ 2,5	≤ 2,5	≤ 2,5
17		N	57,4	57,4	68,9	52,2
18		l 升	0,95	0,95	0,95	0,95
19			Castrol Alphasyn 150	Castrol Alphasyn 150	Castrol Alphasyn 150	Castrol Alphasyn 150















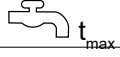
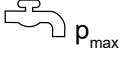
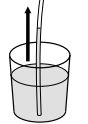

Specifications

			6P-250/1100 FA	6P-120/1950 FA	6P-120/1950 FAXT	6P-120/1950 FA
1			AU	EU	EU	NO
2		V/ph/Hz	415/3/50	400/3/50	400/3/50	230-400/3/50
3		A	20	16	16	32
4		kW кВт	8,5	8,8	8,8	8,8
5		bar (MPa) Бар (МПа) 巴 (兆帕)	250 (25)	120 (12)	120 (12)	120 (12)
6		l/h л/час 升/小时	1000	1850	1850	1850
7		bar (MPa) Бар (МПа) 巴 (兆帕)	250 (25)	175 (17,5)	175 (17,5)	175 (17,5)
8		l/h	1100	1950	1950	1950
9		°C (°F)	80 (176)	80 (176)	80 (176)	80 (176)
10		bar (MPa) Бар (МПа) 巴 (兆帕)	10 (1)	10 (1)	10 (1)	10 (1)
11		m 米	1	1	1	1
12		mm 毫米	775x570x1020	775x570x1020	775x570x1020	775x570x1020
13		kg кг	89	89	96	89
14	 $K_{PA} = 3 \text{ dB}$	dB(A) дБ(A)	80	77	77	77
15	 $K_{WA} = 3 \text{ dB}$	dB(A) дБ(A)	93	90	90	90
16	 (ISO 5349 a_h)	m/s ² 米/秒 ²	≤ 2,5	≤ 2,5	≤ 2,5	≤ 2,5
17		N	54,1	75,9	77,6	75,9
18		l 升	0,95	0,95	0,95	0,95
19			Castrol Alphasyn T 150	Castrol Alphasyn T 150	Castrol Alphasyn T 150	Castrol Alphasyn T 150





Specifications



			7P-195/1280 FA	7P-195/1280 FAXT	7P-195/1280 FA	7P-195/1280 FA
1			EU,DK	EU	NO, BE	EXP
2		V/ph/Hz	400/3/50	400/3/50	230-400/3/50	220-440/3/60
3		A	16	16	25	30
4		kW кВт	8	8	8	8
5		bar (MPa) Бар (МПа) 巴 (兆帕)	195 (19,5)	195 (19,5)	195 (19,5)	195 (19,5)
6		l/h л/час 升/小时	1180	1180	1180	1180
7		bar (MPa) Бар (МПа) 巴 (兆帕)	250 (25)	250 (25)	250 (25)	250 (25)
8		l/h	1280	1280	1280	1280
9		°C (°F)	85 (185)	85 (185)	85 (185)	85 (185)
10		bar (MPa) Бар (МПа) 巴 (兆帕)	10 (1)	10 (1)	10 (1)	10 (1)
11		m 米	1	1	1	1
12		mm 毫米	775x570x1020	930x570x1020	775x570x1020	775x570x1020
13		kg кг	89	95	90	93
14	 $K_{PA} = 3 \text{ dB}$	dB(A) дБ(A)	75	75	76	75
15	 $K_{WA} = 3 \text{ dB}$	dB(A) дБ(A)	88	88	89	88
16	 (ISO 5349 a_h)	m/s ² 米/秒 ²	≤ 2,5	≤ 2,5	≤ 2,5	≤ 2,5
17		N	57,8	58,6	57,8	60
18		l 升	1,1	1,1	1,1	1,1
19			Castrol Alphasyn 150	Castrol Alphasyn 150	Castrol Alphasyn 150	Castrol Alphasyn 150



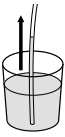

Specifications

			7P-195/1280 FA
1			AU
2		V/ph/Hz	415/3/50
3		A	20
4		kW кВт	8
5	 P _{IEC}	bar (MPa) Бар (МПа) 巴 (兆帕)	195(19,5)
6	 Q _{IEC}	l/h л/час 升/小时	1180
7	 P _{max}	bar (MPa) Бар (МПа) 巴 (兆帕)	250(25)
8	 Q _{MAX}	l/h	1280
9	 t _{max}	°C (°F)	85(185)
10	 p _{max}	bar (MPa) Бар (МПа) 巴 (兆帕)	10 (1)
11		m 米	1
12		mm 毫米	775x570x1020
13		kg кг	89
14	 L _{PA} K _{PA} = 3 dB	dB(A) дБ(A)	75
15	 L _{WA} K _{WA} = 3 dB	dB(A) дБ(A)	88
16	 a _h (ISO 5349 a _h)	m/s ² 米/秒 ²	≤ 2,5
17		N	57,8
18		l 升	1,1
19			Castrol Alphasyn T 150

1			EN: Country variant. DE: Ländervarianten. FR: Selon le pays. NL: Nationale variant. IT: Variante per il Paese. NO: Variant i ulike land. SV: Landsvariant. DA: Landespecifik variant. FI: Maakohmainen vaihtelu. ES: Dependé del país. PT: Variante do país. EL: Έκδοση χώρας. TR: Ülke-deki model. SL: Jezikovna različica. HR: Ovisno o zemlji. SK: Vrsta ulja. CS: Varianta země. PL: Wersja dla kraju. HU: Országfüggő modellváltozatok. RO: Varianta țării. BG: Вариант за страната. RU: Региональное исполнение. ET: Riigi variant. LV: Valsts versija. LT: Šaliai skirtas variantas. JA: 国による相違。 ZH: 不同国家 KO: 국가별 모델. TH: แตกต่างกันไปตามประเทศ MS: Variasi negara.
2		V/ph/Hz	EN: Possible voltage. DE: Mögliche Spannung. FR: Tension autorisée. NL: Mogelijke spanning. IT: Possibile voltaggio. NO: Mulig spenning. SV: Möjlig spänning. DA: Spænding. FI: Mahdollinen jännite, V/vaiheluku/taajuus. ES: Tensión admitida. PT: Tensão possível. EL: Πιθανή τάση, V/ph/Frez. TR: Olası voltaj, V/Faz/Frekans. SL: Morebitna napetost. HR: Mogući napon. SK: Možné napätie. CS: Možné napětí. PL: Dopuszczalne napięcie, V/fazy/częst. HU: Tápészültség, V/fázis/frekv. RO: Tensiune posibilă, V/fază/Frecv. BG: Възможно напрежение. RU: Напряжение, В/φ./част. В/φ./Гц. ET: Võimalik pinge, V/faas/sagedus. LV: iespējamais spriegums. LT: Galima įtampa V / F / Frez. JA: 電圧。 ZH: 可能电压 (V / ph / Freq) KO: 허용 전압, 볼트/상/헤르츠. TH: แรงดันไฟฟ้าที่สามารถใช้ได้ MS: Kemungkinan voltan.
3		A	EN: Fuse. DE: Sicherung. FR: Fusible. NL: Zekering. IT: Fusibile. NO: Sikring. SV: Säkring. DA: Sikring. FI: Sulake. ES: Fusible. PT: Fusível. EL: Ασφάλεια. TR: Sigorta. SL: Varovalka. HR: Osigurač. SK: Poistka. CS: Pojistka. PL: Bezpiecznik. HU: Biztosíték. RO: Siguranță. BG: Предпазител. RU: Предохранитель. ET: Kaitse. LV: Drošinātājs. LT: Saugiklis. JA: ヒューズ. ZH: 保险丝. KO: 퓨즈. TH: ฟิวส์. MS: Fius.
4		kW кВт	EN: Power rating. DE: Nennleistung. FR: Puissance nominale. NL: Nominaal vermogen. IT: Corrente nominale. NO: Nominell effekt. SV: Märkeffekt. DA: Nominel effekt. FI: Tehontarve. ES: Potencia nominal. PT: Classificação de potência. EL: Ονομαστική ισχύς. TR: Elektrik değeri. SL: Moč. HR: Oznaka napona. SK: Stanovenie výkonu. CS: Jmenovitý výkon. PL: Moc znamionowa. HU: Névleges teljesítmény. RO: Putere nominală. BG: Мощност. RU: Номинальная мощность кВт. ET: Vooluühik. LV: Nominālā jauda. LT: Galia. JA: 定格電力。 ZH: 额定功率. KO: 전원 등급. TH: อัตรากำลังไฟ. MS: Penarafan kuasa.
5		bar (MPa) Бар (МПа) 巴 (兆帕)	EN: Working pressure. DE: Arbeitsdruck. FR: Pression de service. NL: Werkdruk. IT: Pressione di esercizio. NO: Arbeidstrykk. SV: Arbetstryck. DA: Arbejdstryk. FI: Työpaine. ES: Presión de trabajo. PT: Pressão de trabalho. EL: Πίεση λειτουργίας. TR: Çalışma basıncı. SL: Delovni tlak. HR: Radni tlak. SK: Pracovný tlak. CS: Provozní tlak. PL: Ciśnienie robocze. HU: Üzemi nyomás. RO: Presiune de lucru. BG: Работно налягане. RU: Рабочее давление. ET: Töösurve. LV: Darba spiediens. LT: Darbinis slėgis. JA: 動作圧力。 ZH: 工作压力. KO: 작업 압력. TH: แรงดันขณะใช้งาน. MS: Tekanan kerja.
6		l/h л/час 升/小时	EN: Water flow. DE: Wasserdurchsatz. FR: Débit d'eau. NL: Waterdoorstroming. IT: Flusso dell'acqua. NO: Vanntilførsel. SV: Vattenflöde. DA: Vandmængde. FI: Vedenvirtaus. ES: Flujo de agua. PT: Fluxo de água. EL: Ροή νερού. TR: Su akışı. SL: Pretok vode. HR: Regulacija protoka vode. SK: Prietok vody. CS: Průtok vody. PL: Przepływ wody. HU: Vízfolyás. RO: Debit apă. BG: Воден поток. RU: Расход воды. ET: Veevool. LV: Ūdens plūsma. LT: Vandens srautas. JA: 流水. ZH: 水流量. KO: 급수량. TH: การไหลของน้ำ. MS: Aliran air.

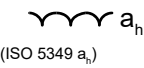
7		bar (MPa) Бар (МПа) 巴 (兆帕)	<p>EN: Max. water pressure. DE: Max Wasserdruck. FR: Pression d'eau maximale. NL: Max. waterdruk. IT: Max. pressione dell'acqua. NO: Maks. vanntrykk. SV: Max vattentryck. DA: Max. vandtryk. FI: Suurin vednpaine. ES: Presión máxima de entrada del agua. PT: Pressão máxima de água. EL: Μέγ. πίεση νερού. TR: Maks. su basıncı. SL: Najv. vodni tlak. HR: Maksimalni tlak vode. SK: Maximálny tlak vody. CS: Max. tlak vody. PL: Maks. ciśnienie wody. HU: Max. víznyomás. RO: Presiune max. apă. BG: Макс. налягане на водата. RU: Макс. давление воды. ET: Max veesurve. LV: Maks. ūdens spiediens. LT: Maks. vandens slėgis. JA: 最高水圧 ZH: 最大水圧 KO: 최대 수압. TH: ความดันน้ำสูงสุด MS: Tekanan air maksimum.</p>
8		l/h	<p>EN: Water flow DE: Wasserdurchsatz. FR: Débit d'eau. NL: Waterdoorstroming. IT: Flusso dell'acqua. NO: Vanntilførsel. SV: Vattenflöde. DA: Vandmængde. FI: Vedevirtaus. ES: Flujo de agua. PT: Fluxo de água. EL: Ποή νερού. TR: Su akışı. SL: Pretok vode. HR: Protok vode. SK: Prietok vody. CS: Průtok vody. PL: Przepływ wody. HU: Vízátfolyás. RO: Debit apă. BG: Воден поток. RU: Расход воды. ET: Veevool. LV: Ūdens plūsma. LT: Vandens srautas. JA: 流水. ZH: 水流量 KO: 급수량. TH: การไหลของน้ำ MS: Aliran air.</p>
9		°C (°F)	<p>EN: Max water inlet temperature, Intake-Pressure operation. DE: Max Wassereinlasstemperatur - Druckbetrieb. FR: Température max. de l'entrée d'eau en mode admission/pression. NL: Max. Waterinlaattemperatuur Inlaat-Tijdens. Bedrijf. IT: Temperatura max. alimentazione acqua Funzionamento a ingressopressione. NO: Maks. temperatur vanninntak, Inntakstrykk drift. SV: Max ingående vattentemperatur inlopps-tryckdrift. DA: Maks. vandtilgangstemperatur, tilgangstrykdrift. FI: Tuloveden suurin lämpötila, käytettäessä painepesurina. ES: Temperatura y presión máxima de entrada del agua. PT: Temperatura máxima de entrada de água, Funcionamento da pressão de entrada. EL: Μεγ. θερμοκρασία εισόδου νερού-λειτουργίας πίεσης. TR: Maks. su girişi sıcaklığı Emme-Basınçlı çalışma. SL: Najv. vstopna temperatura vode, vstopni tlak pri delovanju. HR: Maks. temperatura ulazne vode, tlak pri usisavanju. SK: Max. vstupná teplota vody, Prevádzka v nasávacom režime pod tlakom. CS: Max. teplota vody na vstupu, provozní sací tlak. PL: Maks. temperatura na dopływie wody z instalacji wodociągowej. HU: Max. bemenő vízhőmérséklet Szívónyomásos üzem. RO: Temperatura max. de admisie apă în cazul alimentării de la robinet. BG: Макс. температура на входящата вода – работа в режим на засмукване. RU: Макс. температура воды на входе (всасывание/подача под давлением). ET: Max vee sisselasketemperatuur Sissevoturõhk töö ajal. LV: Maks. ūdens ieplūdes temperatūra ieplūdes-spiediena darbībā. LT: Didžiausia vandens paėmimo temperatūra, veikimas esant įėjimo slėgiui. JA: 最高流入水温度、吸気圧力動作. ZH: 进水压力操作时的最高进水水温 KO: 최대 급수 온도 주입/압력 작동. TH: อุณหภูมิน้ำเข้าสูงสุด ความดันในการใช้งานบริเวณทางเข้า MS: Suhu maksimum air masuk, Kemasukan-Operasi tekanan.</p>
10		bar (MPa) Бар (МПа) 巴 (兆帕)	<p>EN: Max. water inlet pressure. DE: Max. Wassereinlassdruck. FR: d'eau en mode admission/pression. NL: Max. waterinlaatdruk. IT: Pressione max. alimentazione acqua. NO: Maks. trykk vanninntak. SV: Max tryck för vatteninlopp. DA: Maks. Vandtilgangstryk. FI: Tuloveden suurin paine. ES: Presión máxima de entrada del agua. PT: Pressão máxima de entrada de água. EL: Μέγ. πίεση εισόδου νερού. TR: Maks. su girişi basıncı. SL: Najv. tlak dovoda vode. HR: Maks. tlak ulazne vode. SK: Max. vstupný tlak vody. CS: Max. tlak vody na vstupu. PL: Maks. ciśnienie na dopływie wody. HU: Max. bemenő nyomás. RO: Presiunea max. de alimentare cu apă. BG: Макс. налягане на входяща вода. RU: Макс. давление воды на входе. ET: Maks vee sissevoolusurve. LV: Maks. ūdens spiediens. LT: Didžiausias vandens paėmimo slėgis. JA: 最高流入水圧. ZH: 最大进水压力 KO: 최고 급수 압력. TH: ความดันน้ำเข้าสูงสุด MS: Tekanan maksimum air masuk.</p>

11		m 米	<p>EN: Max dry suction height. DE: Max. Trockensaughöhe. FR: Hauteur d'aspiration à sec max. NL: Max. droge aanzuighoogte. IT: Altezza massima di aspirazione secco. NO: Maks. sugehøyde tørr. SV: Max torr-sugningshöjd. DA: Maks. sugehøjde, tør. FI: Suurin kuivaimukorkeus. ES: Altura máxima de succión en seco. PT: Altura de aspiração a seco máx. EL: Μέγ. ύψος αναρρόφησης. TR: Maks. Kuru emme yüksekliği. SL: Najv. višina suhega vsesavanja. HR: Maks. visina pri suhom usisavanju. SK: Max. suchá nasávacia výška. CS: Max. sací výška nasucho. PL: Maks. wysokość ssania na sucho. HU: Max. száraz szívómagasság. RO: Înălțime max. de aspirare în cazul alimentării cu apă dintr-un recipient. BG: Макс. височина на сухо засмукване. RU: Макс. высота всасывания. ET: Max kuivimu kõrgus. LV: Maks. sausās sūkšanas augstums. LT: Maksimalus sausas įsiurbimo aukštis. JA: 最大乾燥吸込高さ。 ZH: 最大干吸高度 米 KO: 최대 건조 흡입 높이. TH: ความสูงของท่อดูดแห้งสูงสุด MS: Ketinggian maksimum sedutan kering.</p>
12		mm 毫米	<p>EN: Dimensions LxWxH. DE: Masse LxBxH. FR: Dimensions l x p x h. NL: Afmetingen LxBxH. IT: Dimensioni, lun. x larg. x alt. NO: Mål LxBxH. SV: Dimensioner LxBxH. DA: Mål LxBxH. FI: Mitat, PxLxK. ES: Dimensiones l x a x al. PT: Dimensões, C x L x A. EL: Διαστάσεις, Μ x Π x Υ. TR: Boyutlar, u x g x y. SL: Mere D x Š x V. HR: Dimenzije DxŠxV. SK: Rozmery D x Š x V. CS: Rozměry d x š x v. PL: Wymiary długość x szer. x wys. HU: Méretek H x Sz x M. RO: Dimensiuni. L x l x î. BG: Размери Д x Ш x В. RU: Размеры, Дл. x Шир. x Выс. ET: Mõõtmed p x l x k. LV: Izmēri G x P x A. LT: Matmenys (i x p x a). JA: 外形寸法長さx幅x高さ。 ZH: 尺寸 (长x宽x高) 毫米 KO: 크기(l x w x h). TH: ขนาด ยาว x กว้าง x สูง MS: Dimensi LxWxH.</p>
13		kg кг	<p>EN: Weight. DE: Gewicht. FR: Poids du nettoyeur. NL: Gewicht van de hogedrukreiniger. IT: Peso dell'idropulitrice. NO: Vekt høytrykksvasker. SV: Maskinens vikt. DA: Vægt. FI: Pelkän painepesurin paino. ES: Peso del limpiador. PT: Peso da máquina de limpeza. EL: Βάρος μηχανήματος καθαρισμού. TR: Temizlik makinesinin yüksekliği. SL: Masa. HR: Težina. SK: Hmotnosť. CS: Hmotnost čisticího stroje. PL: Ciężar myjki. HU: Tisztítógép tömege. RO: Greutatea aparatului. BG: Тегло. RU: Вес моющей машины. ET: Pesuri kaal. LV: Tīrītāja svars. LT: Valymo įrenginio svoris. JA: 重量。 ZH: 清洗机重量 KO: 세척기 무게. TH: น้ำหนัก MS: Berat.</p>
14	 $K_{PA} = 3 \text{ dB}$	dB(A) дБ(А)	<p>EN: Sound pressure level L_{PA}. DE: Schalldruckpegel. FR: Niveau de pression acoustique. NL: Geluidsdrukniveau. IT: Livello pressione sonora. NO: Lydtrykknivå. SV: Ljudtrycksnivå. DA: Lydtryksniveau. FI: Äänenpainetaso. ES: Nivel de presión sonora. PT: Nível de pressão acústica. EL: Επίπεδο πίεσης ήχου. TR: Göre ses basıncı seviyesi. SL: Raven zvočnega tlaka. HR: Razina zvučnog tlaka. SK: Hladina zvukového. CS: Hladina akustického tlaku. PL: Poziom ciśnienia akustycznego. HU: Hangnyomásszint. RO: Nivel de presiune acustică. BG: Ниво на звуково налягане. RU: Уровень шума. ET: Helisurve tase. LV: Akustiskā spiediena līmenis. LT: Garso slėgio lygis. JA: 音圧レベル. ZH: 声压级. KO: 음압 레벨. TH: ระดับความดันเสียง. MS: Tahap tekanan bunyi.</p>
15	 $K_{WA} = 3 \text{ dB}$	dB(A) дБ(А)	<p>EN: Sound power level L_{WA}. DE: Schallleistungspegel. FR: Niveau de puissance acoustique. NL: Geluidsvermogeniveau. IT: Livello potenza sonora. NO: Lydeffektnivå. SV: Ljudeffektnivå. DA: Lydeffektniveau. FI: Äänen tehotaso. ES: Potencia acústica. PT: Nível de potência acústica. EL: Επίπεδο ισχύος ήχου. TR: Göre ses basıncı seviyesi. SL: Raven moči zvoka. HR: Razina jakosti. SK: Hladina zvukového výkonu. CS: Hladina akustického výkonu. PL: Poziom mocy akustycznej. HU: Hangteljesítmény szint. RO: Nivelul de putere acustică. BG: Ниво на звукова мощност. RU: Уровень звуковой мощности. ET: Helivõimsuse tase. LV: Akustiskās jaudas līmenis. LT: Garso galios lygis. JA: 音響パワーレベル. ZH: 声功率级. KO: 소음 레벨. TH: ระดับกำลังเสียง. MS: Tahap kuasa bunyi.</p>

16a	 (ISO 5349 a _h)	m/s^2 米/秒 ²	EN: Vibration. DE: Vibrationen FR: Vibration NL: Vibratie IT: Vibrazioni NO: Vibrasjoner SV: Vibration DA: Vibration FI: Tärinäarvot ES: Vibración PT: Vibração EL: Δόνηση TR: Titreşimi SL: Vibracije. HR: Vibracije. SK: Vibrácie. CS: Vibrace PL: Drgania HU: Vibráció RO: Vibrații BG: Вибрации. RU: Вибрация ET: vibratsioon LV: vibrācija LT: Vibracijos JA: 振動。 ZH: 振动 KO: 진동 TH: แรงสั่นสะเทือน MS: Getaran.
17		N	EN: Recoil forces, lance. DE: Rückstoßkraft, Sprühhrohr FR: Forces de recul, lance NL: Terugslagkracht, lans IT: Forze di rinculo, lancia NO: Rekylkraft, lanse SV: Rekylkraft, spolrör DA: Rekylkraft, dyserør FI: Rekyylivoimat, suutin ES: Fuerzas de retroceso, lanza PT: Forças de retrocesso, lança EL: Δυνάμεις οπισθοδρόμησης, διάταξη ψεκασμού χη. TR: Sarmal kuvvetler, boru SL: Povratne sile, šoba. HR: Trzajne sile, mlaznica. SK: Spätný odraz, štandardná striekacia rúra. CS: Síly zpětného rázu, násadec PL: Siły odrzutu, lanca HU: Visszaható erő, szórócső RO: Forțe de recul, tija BG: Сили на откат, накрайник. RU: Сила отдачи (распылитель). ET: Tagasilöögi jõud, otsik LV: Atsitiena spēks, smidzinātājs LT: Atatrankos jėga, antgalis JA: 反跳力、ランス。 ZH: 反冲力 (喷杆) KO: 반동력, 랜스 TH: แรงสะท้อนถอยหลัง, ป้ายทอ MS: Kuasa sentakan, lans.
18		l 升	EN: Oil quantity. DE: Ölmenge. FR: Quantité d'huile. NL: Hoeveelheid olie. IT: Quantità olio. NO: Oljemengde. SV: Oljemängd. DA: Oliemængde. FI: Öljymäärä. ES: Cantidad de aceite. PT: Quantidade de óleo. EL: Ποσότητα λαδιού. TR: Yağ miktarı. SL: Količina olja. HR: Količina ulja. SK: Množstvo oleja. CS: Množství oleje. PL: Objętość oleju. HU: Olajmennyiség. RO: Cantitate de ulei. BG: Количество на маслото. RU: Количество масла. ET: Õli kogus. LV: Eļļas daudzums. LT: Tepalo kiekis. JA: オイル量。 ZH: 油量升 KO: 오일량 TH: ปริมาณน้ำมัน MS: Kuantiti minyak.
19			EN: Oil type. DE: Öltyp. FR: Type d'huile. NL: Olietype. IT: Tipo olio. NO: Oljetype. SV: Typ av olja. DA: Olietype. FI: Öljyn tyyppi. ES: Tipo de aceite. PT: Tipo de óleo. EL: Τύπος λαδιού. TR: Yağ tipi. SL: Vrsta olja. HR: Vrsta ulja. SK: Typ oleja. CS: Typ oleje. PL: Typ oleju. HU: Olaj típusa. RO: Tip de ulei. BG: Тип на маслото. RU: Тип масла. ET: Õli tüüp. LV: Eļļas tips. LT: Tepalo tipas. JA: オイルの種類。 ZH: 油型 KO: 오일 유형 TH: ประเภทน้ำมัน MS: Jenis minyak.
20			EN: Specifications and details are subject to change without prior notice. DE: Technische Daten und Details des Geräts können sich ohne vorherige Ankündigung ändern. FR: Ces spécifications et détails sont susceptibles d'être modifiés sans préavis. NL: Specificaties en details kunnen zonder voorafgaande waarschuwing worden gewijzigd. IT: Specifiche e dettagli sono soggetti a modifiche senza preavviso. NO: Spesifikasjonene og detaljene er gjenstand for endringer uten forutgående varsel. SV: Specifikationer och information kan ändras utan föregående meddelande. DA: Ret til ændringer i konstruktion og specifikationer forbeholdes. FI: Rakenteeseen ja teknisiin tietoihin voidaan tehdä muutoksia ilmoittamatta niistä ennalta. ES: Las especificaciones y los datos están sujetos a cambios sin previo aviso. PT: As especificações e os detalhes estão sujeitos a alterações sem aviso prévio. EL: Τα τεχνικά χαρακτηριστικά και οι λεπτομέρειες υπόκεινται σε αλλαγές χωρίς προηγούμενη ειδοποίηση. TR: Özellikler ve ayrıntılar, önceden haber verilmeden değiştirilebilir. SL: Tehnični podatki in podrobnosti se lahko spremenijo brez predhodnega obvestila. HR: Specifikacije i detalji mogu se mijenjati bez prethodne najave. SK: Špecifikácie a podrobnosti sa môžu meniť bez predchádzajúceho upozornenia. CS: Technické údaje a detaily mohou být změněny i bez předchozího upozornění. PL: Specyfikacje i parametry mogą zostać zmienione bez uprzedzenia. HU: A műszaki adatok és részletek előzetes értesítés nélkül megváltozhatnak. RO: Specificațiile și detaliile pot fi modificate fără înștiințare prealabilă. BG: Спецификациите и детайлите подлежат на промяна без предварително уведомление. RU: Технические характеристики и данные могут изменяться без предварительного извещения. ET: Tehnilisi kirjeldusi ja üksikasju võidakse muuta eelneva etteatamiseta. LV: Specifikācijas un detaļas var tikt mainītas bez iepriekšēja paziņojuma. LT: Konstrukcija ir specifikacijos gali keistis be išankstinio įspėjimo. JA: 仕様および情報は事前通知無しに変更する場合があります。 ZH: 规格和详情如有变更，恕不另行通知。 KO: 사양 및 내용은 예고없이 변경될 수 있습니다. TH: ข้อกำหนดเฉพาะและรายละเอียดสามารถเปลี่ยนแปลงได้โดยไม่ต้องแจ้งให้ทราบล่วงหน้า MS: Spesifikasi dan butiran adalah tertakluk kepada perubahan tanpa notis terlebih dahulu.



HEAD QUARTER

DENMARK

Nilfisk A/S
Kornmarksvej 1
DK-2605 Broendby
Tel.: (+45) 4323 8100
www.nilfisk.com

SALES COMPANIES

ARGENTINA

Nilfisk Argentina
Herrera 1855 Piso 4° B Ofic 405
Ciudad de Buenos Aires
Tel.: (+54) 11 6091 1576
www.nilfisk.com.ar

AUSTRALIA

Nilfisk Pty Ltd
Unit 1/13 Bessemer Street
Blacktown NSW 2148
Tel.: (+61) 2 98348100
www.nilfisk.com.au

AUSTRIA

Nilfisk GmbH
Metzgerstrasse 68
5101 Bergheim bei Salzburg
Tel.: (+43) 662 456 400 90
www.nilfisk.at

BELGIUM

Nilfisk n.v.s.a.
Riverside Business Park
Boulevard Internationalelaan 55
Bâtiment C3/C4 Gebouw
Bruxelles 1070
Tel.: (+32) 24 67 60 50
www.nilfisk.be

BRAZIL

Nilfisk do Brasil
Av. Eng. Luis Carlos Berrini, 550
40 Andar, Sala 03
SP - 04571-000 Sao Paulo
Tel.: (+11) 3959-0300 / 3945-4744
www.nilfisk.com.br

CANADA

Nilfisk Canada Company
240 Superior Boulevard
Mississauga, Ontario L5T 2L2
Tel.: (+1) 800-668-8400
www.nilfisk.ca

CHILE

Nilfisk S.A. (Comercial KCS Ltda)
Salar de Llamara 822
8320000 Santiago
Tel.: (+56) 2684 5000
www.nilfisk.cl

CHINA

Nilfisk
4189 Yindu Road
Xinzhuang Industrial Park
201108 Shanghai
Tel.: (+86) 21 3323 2000
www.nilfisk.cn

CZECH REPUBLIC

Nilfisk s.r.o.
VGP Park Horní Počernice
Do Čertous 1/2658
193 00 Praha 9
Tel.: (+420) 244 090 912
www.nilfisk.cz

DENMARK

Nilfisk Danmark A/S
Industrivej 1
Hadsund, DK-9560
Tel.: 72 18 21 20
www.nilfisk.dk

FINLAND

Nilfisk Oy Ab
Koskelontie 23 E
02920 Espoo
Tel.: (+358) 207 890 600
www.nilfisk.fi

FRANCE

Nilfisk SAS
26 Avenue de la Baltique
Villebon sur Yvette
91978 Courtabouef Cedex
Tel.: (+33) 169 59 87 00
www.nilfisk.fr

GERMANY

Nilfisk GmbH
Guido-Oberdorfer-Straße 2-10
89287 Bellenberg
Tel.: (+49) (0)7306/72-444
www.nilfisk.de

GREECE

Nilfisk A.E.
Αναπαύσεως 29
Κορωπί Τ.Κ. 194 00
Tel.: (30) 210 9119 600
www.nilfisk.gr

HOLLAND

Nilfisk B.V.
Versterkerstraat 5
1322 AN Almere
Tel.: (+31) 036 5460760
www.nilfisk.nl

HONG KONG

Nilfisk Ltd.
2001 HK Worsted Mills
Industrial Building
31-39, Wo Tong Tsui St.
Kwai Chung, N.T.
Tel.: (+852) 2427 5951
www.nilfisk.com

HUNGARY

Nilfisk Kft.
II. Rákóczi Ferenc út 10
2310 Szigetszentmiklós-Lakihegy
Tel.: (+36) 24 475 550
www.nilfisk.hu

INDIA

Nilfisk India Limited
Pramukh Plaza, 'B' Wing, 4th floor,
Unit No. 403
Cardinal Gracious Road, Chakala
Andheri (East) Mumbai 400 099
Tel.: (+91) 22 6118 8188
www.nilfisk.in

IRELAND

Nilfisk
1 Stokes Place
St. Stephen's Green
Dublin 2
Tel.: (+35) 3 12 94 38 38
www.nilfisk.ie

ITALY

Nilfisk SpA
Strada Comunale della Braglia, 18
26862 Guardamiglio (LO)
Tel.: (+39) (0) 377 414021
www.nilfisk.it

JAPAN

Nilfisk Inc.
1-6-6 Kita-shinyokohama, Kouhoku-ku
Yokohama, 223-0059
Tel.: (+81) 45548 2571
www.nilfisk.com

MALAYSIA

Nilfisk Sdn Bhd
Sd 33, Jalan KIP 10
Taman Perindustrian KIP
Sri Damansara
52200 Kuala Lumpur
Tel.: (60) 3603 627 43 120
www.nilfisk.com

MEXICO

Nilfisk de Mexico, S. de R.L. de C.V.
Pirineos #515 Int.
60-70 Microparque
Industrial WSantiago
76120 Queretaro
Tel.: (+52) (442) 427 77 00
www.nilfisk.com

NEW ZEALAND

Nilfisk Limited
Suite F, Building E
42 Tawa Drive
0632 Albany Auckland
Tel.: (+64) 9 414 1996
Website: www.nilfisk.com

NORWAY

Nilfisk AS
Bjørnerudveien 24
1266 Oslo
Tel.: (+47) 22 75 17 80
www.nilfisk.no

PERU

Nilfisk S.A.C.
Calle Boulevard 162, Of. 703, Lima
33- Perú
Lima
Tel.: (511) 435-6840
www.nilfisk.com

POLAND

Nilfisk Sp. Z.O.O.
Millenium Logistic Park
ul. 3 Maja 8, Bud. B4
05-800 Pruszków
Tel.: (+48) 22 738 3750
www.nilfisk.pl

PORTUGAL

Nilfisk Lda.
Sintra Business Park
Zona Industrial Da Abrunheira
Edifício 1, 1° A
P2710-089 Sintra
Tel.: (+351) 21 911 2670
www.nilfisk.pt

RUSSIA

Nilfisk LLC
Vyatskaya str. 27, bld. 7/1st
127015 Moscow
Tel.: (+7) 495 783 9602
www.nilfisk.ru

SINGAPORE

Den-Sin
22 Tuas Avenue 2
639453 Singapore
Tel.: (+65) 6268 1006
www.densin.com

SLOVAKIA

Nilfisk s.r.o.
Bancikovej 1/A
SK-821 03 Bratislava
Tel.: (+421) 910 222 928
www.nilfisk.sk

SOUTH AFRICA

Nilfisk (Pty) Ltd
Kimbult Office Park
9 Zeiss Road
Laser Park
Honeydew
Johannesburg
Tel.: +27118014600
www.nilfisk.co.za

SOUTH KOREA

Nilfisk Korea
#204 2F Seoulsup Kolon Digital
Tower
25 Seongsuil-ro 4-gil, Seongdong-gu
Seoul.
Tel.: (+ 82) 2 3474 4141
www.nilfisk.co.kr

SPAIN

Nilfisk S.A.
Torre d'Ara,
Passeig del Rengle, 5 Plta. 10ª
08302 Mataró
Tel.: (34) 93 741 2400
www.nilfisk.es

SWEDEN

Nilfisk AB
Taljegårdsgatan 4
431 53 Mölndal
Tel.: (+46) 31 706 73 00
www.nilfisk.se

SWITZERLAND

Nilfisk AG
Ringstrasse 19
Kircheberg/Industri Stelz
9500 Wil
Tel.: (+41) 71 92 38 444
www.nilfisk.ch

TAIWAN

Nilfisk Ltd
Taiwan Branch (H.K.)
No. 5, Wan Fang Road
Taipei
Tel.: (+88) 6227 00 22 68
www.nilfisk.tw

THAILAND

Nilfisk Co. Ltd.
89 Soi Chokechai-Ruammitr
Viphavadee-Rangsit Road
Ladyao, Jatuchak, Bangkok 10900
Tel.: (+66) 2275 5630
www.nilfisk.co.th

TURKEY

Nilfisk A.S.
Serifali Mh. Bayraktar Bulv. Sehiz
Sk. No:7
Ümraniye, 34775 Istanbul
Tel.: +90 216 466 94 94
www.nilfisk.com.tr

UNITED ARAB EMIRATES

Nilfisk Middle East Branch
SAIF-Zone
P.O. Box 122298
Sharjah
Tel.: (+971) (0) 655-78813
www.nilfisk.com

UNITED KINGDOM

Nilfisk Ltd.
Nilfisk House, Bowerbank Way
Gilwilly Industrial Estate, Penrith
Cumbria CA11 9BQ
Tel.: (+44) (0) 1768 868995
www.nilfisk.co.uk

UNITED STATES

Nilfisk, Inc.
9435 Winnetka Ave N,
Brooklyn Park
MN- 55445
www.nilfisk.com

VIETNAM

Nilfisk Vietnam
No. 51 Doc Ngu Str.
P. Vinh Phúc, Q.Ba Dinh
Hanoi
Tel.: (+84) 761 5642
www.nilfisk.com

