

# ATTIX 30 - ATTIX 40 - ATTIX 50 US

## Instructions for use

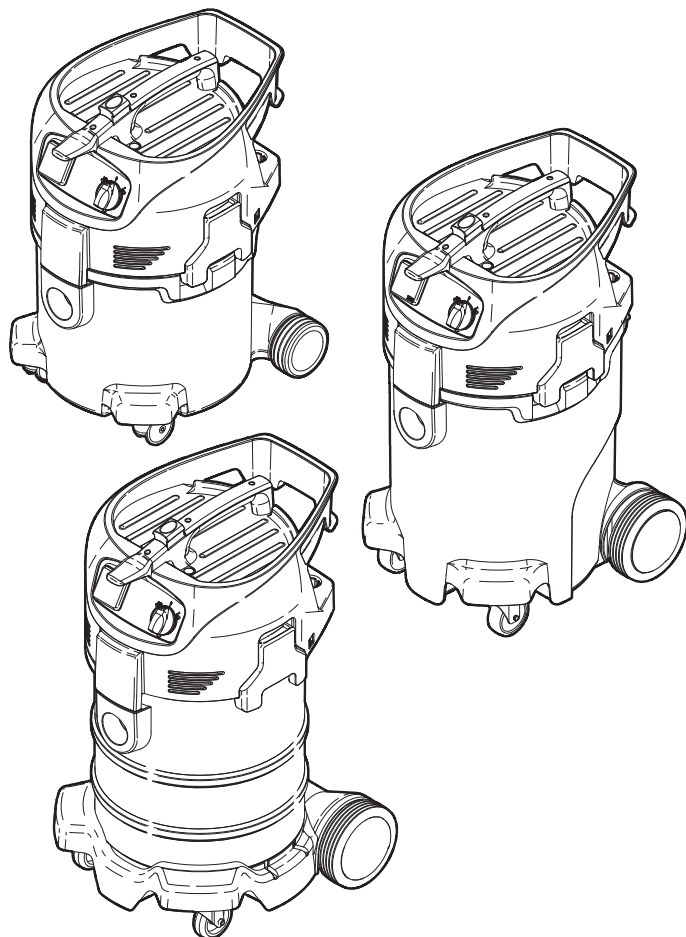

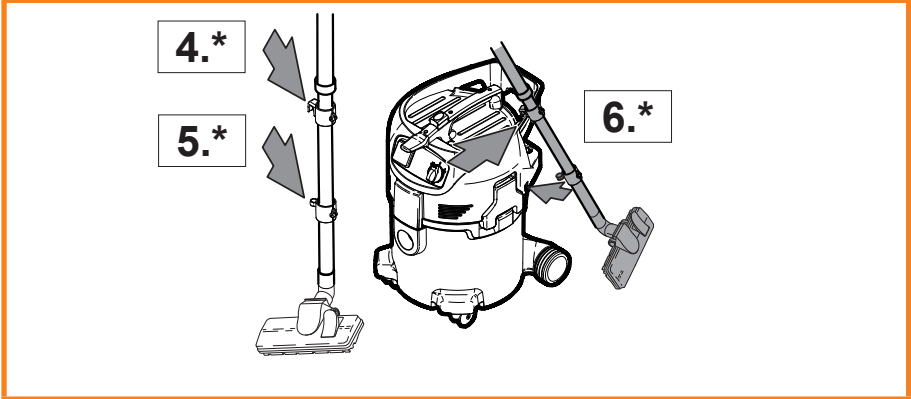
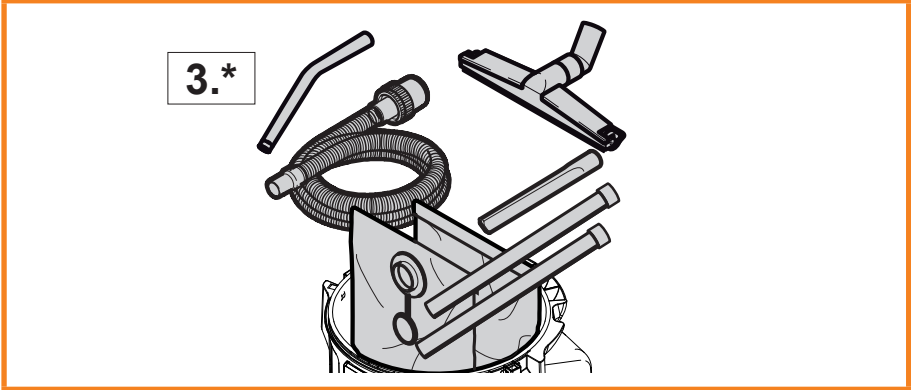
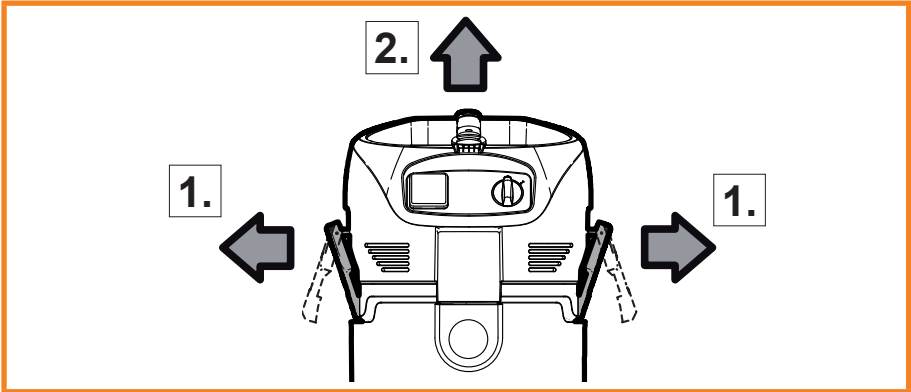
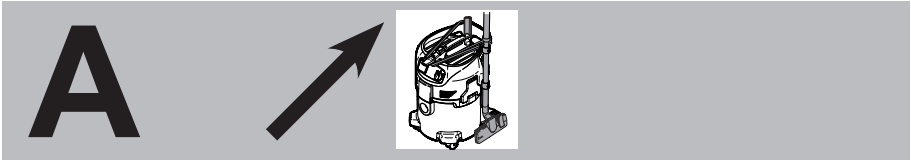

A

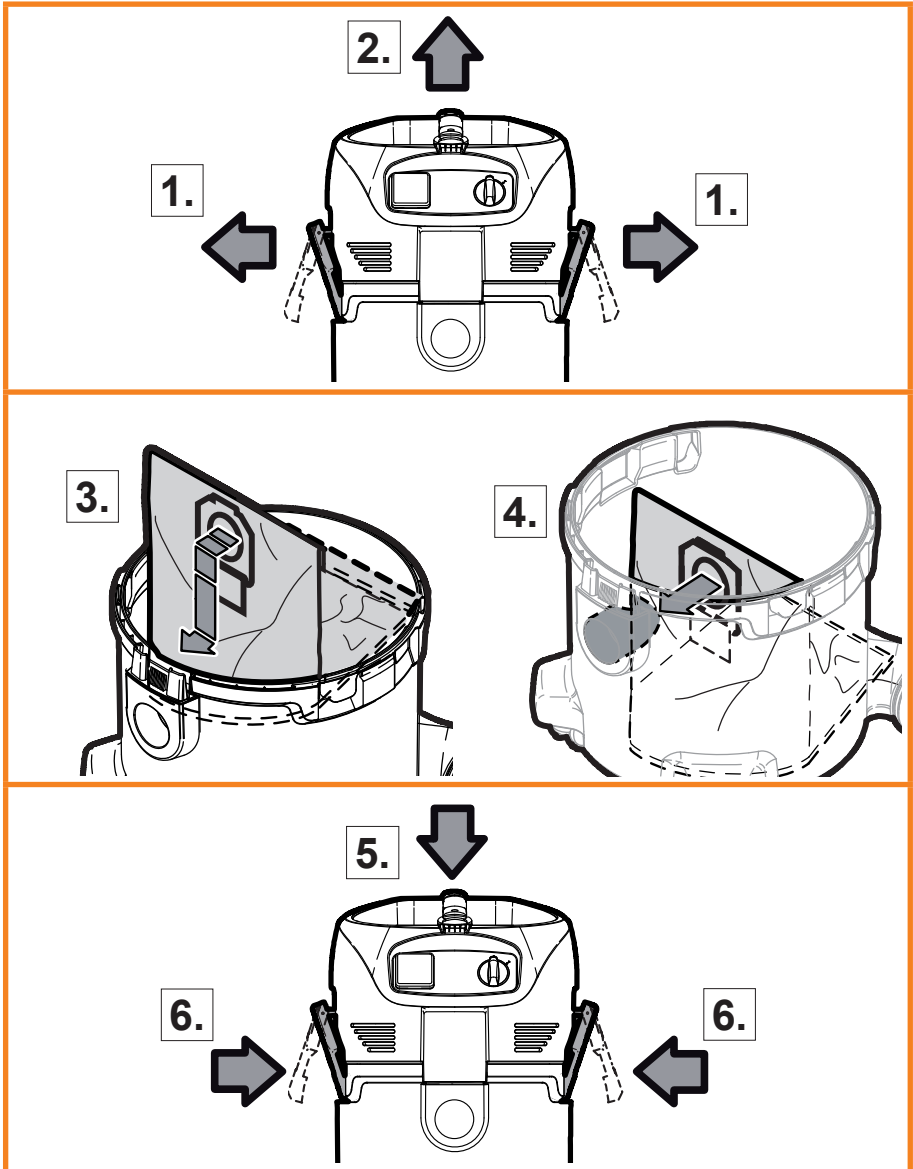
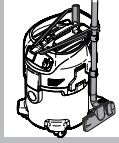

# B

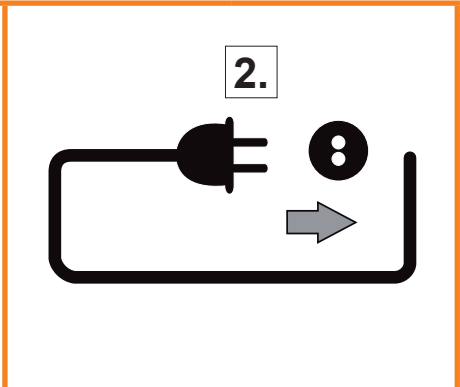
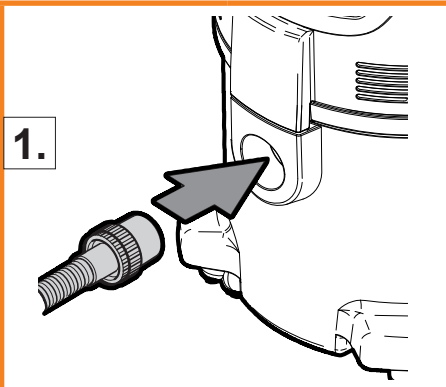

**ATTIX 30- / 40- / 50-01**  
**ATTIX 30- / 40- / 50-11**

**ATTIX 30- / 40- / 50-21**

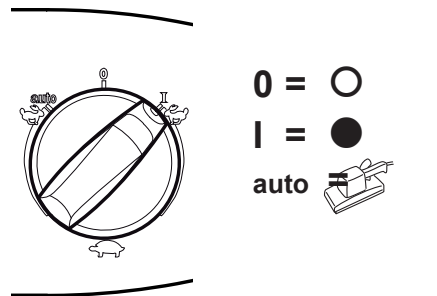
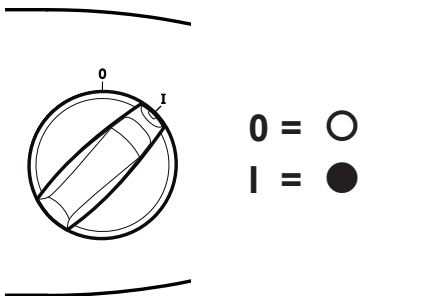

**ATTIX 30- / 40- / 50-21**

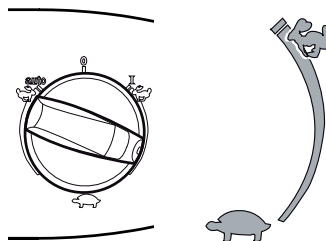

# B



## ATTIX 30- / 40- / 50-xx PC

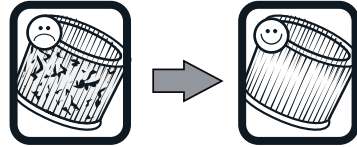

## ATTIX 30- / 40- / 50-xx XC

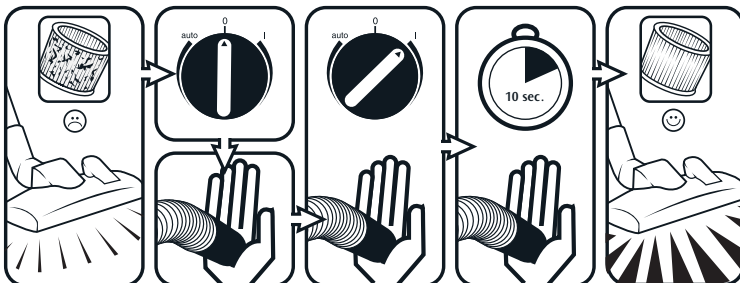
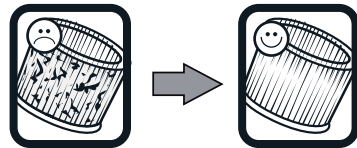

# B\*

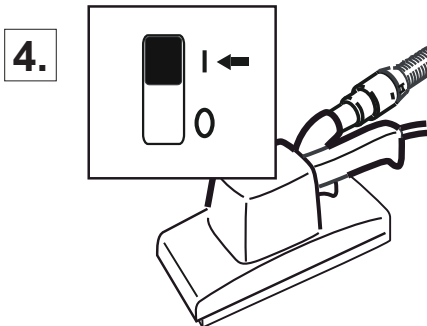
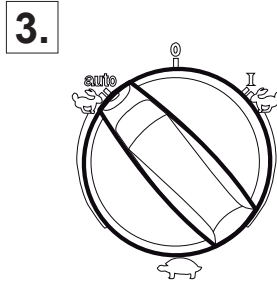
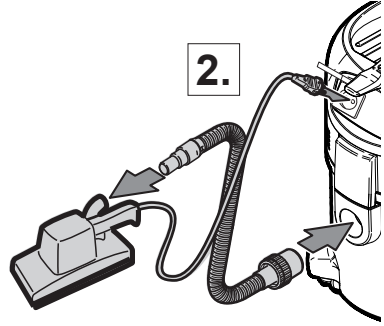
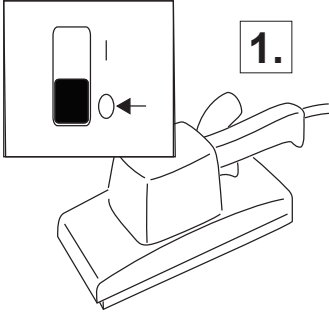
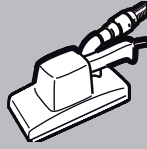

# C

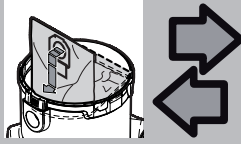

## ATTIX 30 / 40 / 50

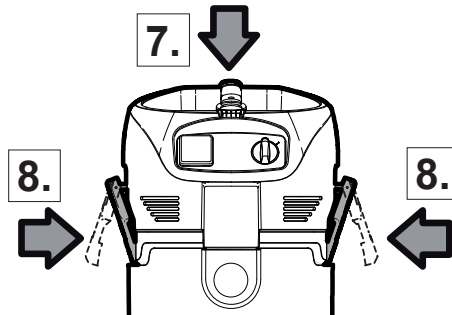
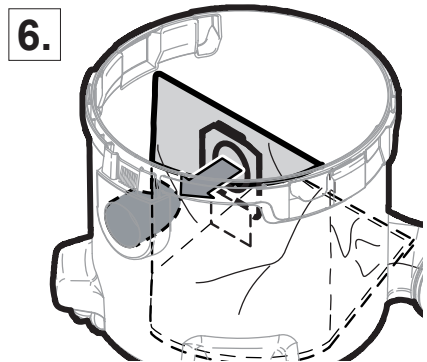
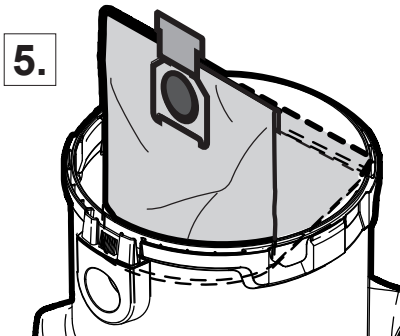
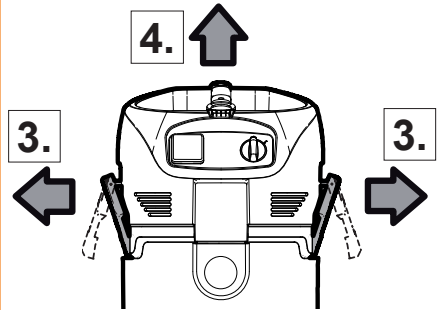
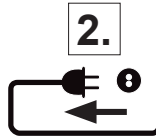
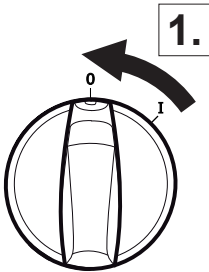

# C



## ATTIX 30 / 40 / 50

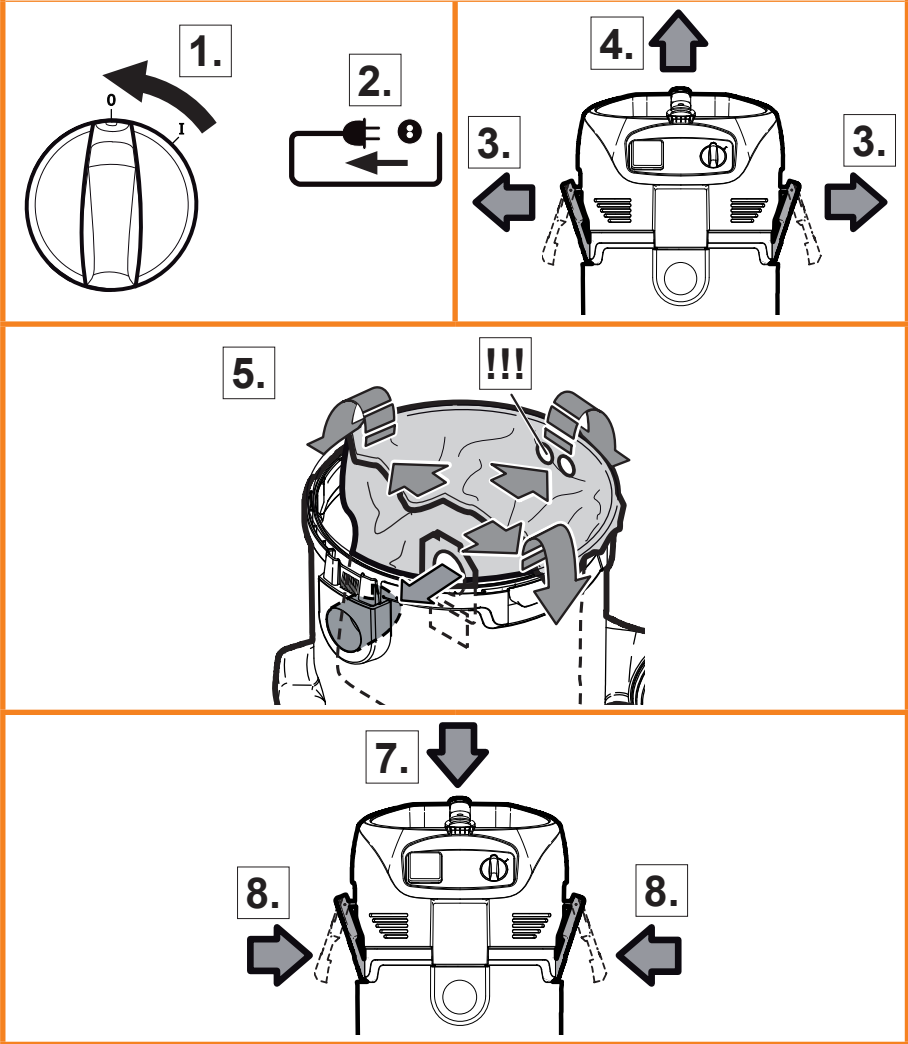



**C**

## ATTIX 30 / 40 / 50 / STD / PC

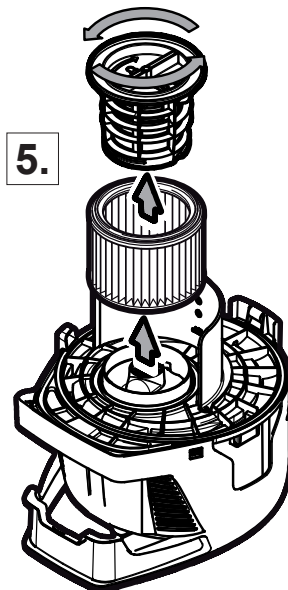
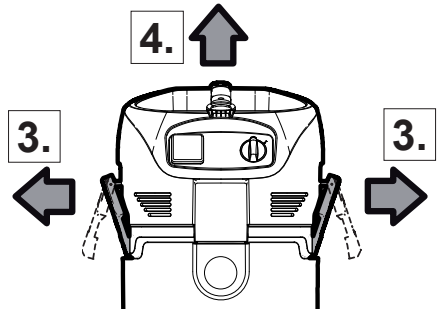
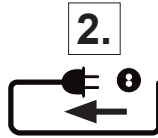
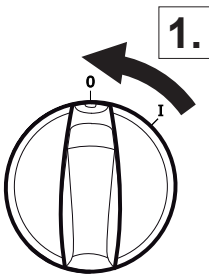

# C



## ATTIX 30 / 40 / 50 XC

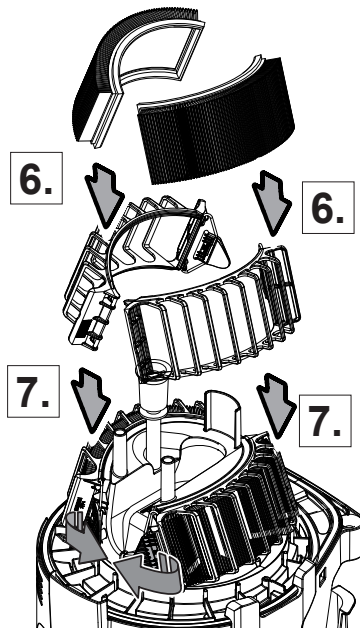
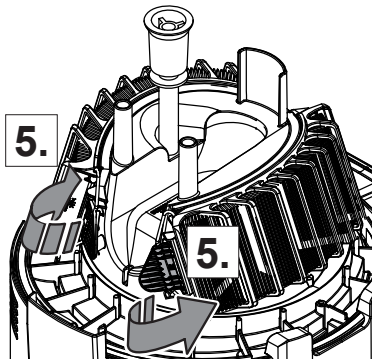
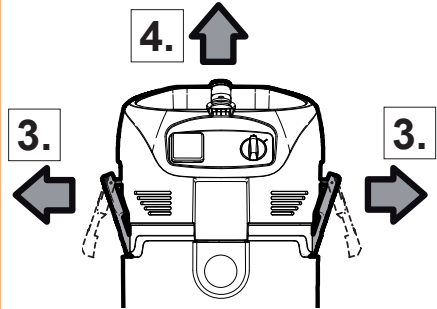
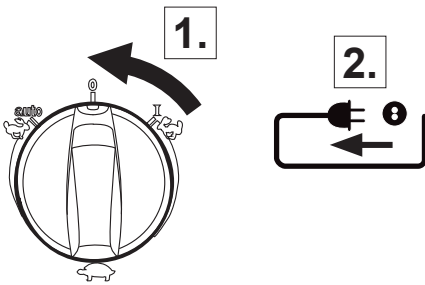

# D

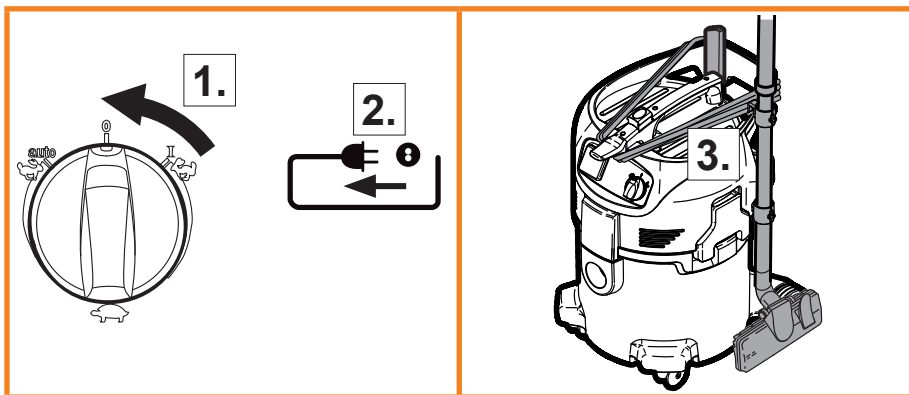

## This document

This document contains the safety information relevant for the appliance along with a quick reference guide.



Prior to using the appliance for the first time, be sure to read this document through and keep it ready to

hand.

### Further support

Detailed information on the appliance can be found in the operating instructions, which you can download from our web site at [www.nilfisk.com](http://www.nilfisk.com).

For further queries, please contact the Nilfisk service representative responsible for your country.

See reverse of this document.

## Important safety instructions

### Symbols used to mark instructions

	<b>DANGER</b>
	Danger that leads directly to serious or irreversible injuries, or even death.

	<b>WARNING</b>
	Danger that can lead to serious injuries or even death.

	<b>CAUTION</b>
	Danger that can lead to minor injuries and damage.

The appliance must

- only be used by persons, who have been instructed in its correct usage and explicitly commissioned with the task of operating it
- only be operated under supervision
- not be used by children

1. Do not use any unsafe work techniques.
2. Never use the vacuum cleaner without a filter.
3. Switch off the appliance and disconnect the mains plug in the following situations:
  - Prior to cleaning and servicing

- Prior to replacing components
- Prior to changing over the appliance
- If foam develops or liquid emerges

Besides the operating instructions and the binding accident prevention regulations valid in the country of use, observe recognised regulations for safety and proper use.

### Purpose and intended use

The appliance is suitable for picking up dry, non-flammable dust and liquids.

The appliance is suitable for commercial use, such as e.g. in

- Hotels, Schools, Hospitals, Factories, Shops, Offices, Hire shops

Any other use is considered as improper use. The manufacturer accepts no liability for any damage resulting from such use. The risk for such use is borne solely by the user.

Proper use also includes proper operation, servicing and repairs as specified by the manufacturer. See operating instructions.

### Transport

1. Before transporting the dirt tank, close all the locks.
2. Do not tilt the cleaner if there is liquid in the dirt tank.
3. Do not use a crane hook to lift the cleaner.

### Storage

1. Store the appliance in a dry place, protected from frost.

### Electrical connection

1. It is recommended that the vacuum cleaner should be connected via a residual current circuit breaker.
2. Arrange the electrical parts (sockets, plugs and couplings) and lay down the extension lead so that the protection class is maintained.
3. Connectors and couplings of power supply cords and extension leads must be watertight.

### Extension lead

1. As an extension lead, only use the version specified by the manufacturer or one of a higher quality. See operating instructions.
2. When using an extension lead, check the minimum cross-sections of the cable:

Cable length	Cross section	
	< 16 A	< 25 A
up to 20 m	1.5 mm <sup>2</sup>	2.5 mm <sup>2</sup>
20 to 50 m	2.5 mm <sup>2</sup>	4.0 mm <sup>2</sup>

### Warranty

Our general conditions of business are applicable with regard to the guarantee. Unauthorised modifications to the appliance, the use of incorrect brushes in addition to using the appliance in a way other than for the intended purpose exempt the manufacturer from any liability for the resulting damage.

### Tests and approvals

Electrical tests must be performed in accordance with the provisions of safety regulations (BGV A3) and to DIN VDE 0701 Part 1 and Part 3. In accordance with DIN VDE 0702 these tests must be performed at regular intervals and after repairs or modifications.

## Risks

### Electrical components



#### DANGER

Electric shock due to faulty mains connecting lead.

Touching a faulty mains connecting lead can result in serious or even fatal injuries.

1. Do not damage the mains power lead (e.g. by driving over it, pulling or crushing it).
2. Regularly check whether the power cord is damaged or shows signs of ageing.
3. Have the faulty mains connecting lead replaced by your Nilfisk service representative or a qualified electrician prior to using the appliance again.



#### DANGER

The upper section of the vacuum cleaner contains live components.

Contact with live components leads to serious or even fatal injuries.

1. Never spray water on to the upper section of the vacuum cleaner.



#### CAUTION

Appliance socket<sup>1)</sup>.

The appliance socket is only designed for the purposes defined in the operating instructions. The connection of different appliances can result in damage.

1. Prior to plugging in an appliance, always switch off the vacuum cleaner and the appliance that is to be connected.
2. Read the operating instructions to the appliance to be connected and observe the safety notes contained in these.

<b>CAUTION</b>	
	<p>Damage due to unsuitable mains voltage.</p> <p>The appliance can be damaged as a result of being connected to an unsuitable mains voltage.</p> <ol style="list-style-type: none"> <li>1. Ensure that the voltage shown on the rating plate corresponds to the voltage of the local mains power supply.</li> </ol>

**Picking up liquids**

<b>CAUTION</b>	
	<p>Picking up liquids.</p> <p>Do not pick up flammable liquids.</p> <ol style="list-style-type: none"> <li>1. Before liquids are picked up, always remove the filter bag/waste bag and check that the float or the water level limit works properly.</li> <li>2. The use of a separate filter element or filter screen is recommended.</li> <li>3. If foam appears, stop work immediately and empty the tank.</li> </ol>

**Hazardous materials**

<b>WARNING</b>	
	<p>Hazardous materials.</p> <p>Vacuuming up hazardous materials can lead to serious or even fatal injuries</p> <ol style="list-style-type: none"> <li>1. The following materials must not be picked up by the vacuum cleaner: <ul style="list-style-type: none"> <li>- hazardous dust</li> <li>- hot materials (burning cigarettes, hot ash, etc.)</li> <li>- flammable, explosive, aggressive liquids (e.g. petrol, solvents, acids, alkalis, etc.)</li> <li>- flammable, explosive dust (e.g. magnesium or aluminium dust, etc.)</li> </ul> </li> </ol>

**Spare parts and accessories**

<b>CAUTION</b>	
	<p>Spare parts and accessories.</p> <p>The use of non-genuine spare parts and accessories can impair the safety of the appliance.</p> <ol style="list-style-type: none"> <li>1. Only use spare parts and accessories from Nilfisk.</li> <li>2. Use only the brushes supplied with the vacuum cleaner or specified in the operating manual.</li> </ol>

**Emptying dirt tank**

<b>CAUTION</b>	
	<p>Picking up environmentally hazardous materials.</p> <p>Materials picked up can present a hazard to the environment.</p> <ol style="list-style-type: none"> <li>1. Dispose of the dirt in accordance with legal regulations.</li> </ol>

**Recycling the cleaner**

Make the old cleaner unusable immediately.

1. Unplug the cleaner.
2. Cut the power cord.
3. Do not discard of electrical appliances with household waste.



As specified in European Directive 2012/19/EC on old electrical and electronic appliances, used electrical goods must be collected separately and recycled ecologically. Contact your local authorities or your nearest dealer for further information.







## Quick reference guide

Pages 2 – 12 feature a pictorial quick reference guide, which is designed to help you when starting up, operating and storing the appliance.

This quick reference guide does not replace the separate operating instructions, which describes the appliance in detail. The operating instructions also contain further information on the operation, maintenance and repair of the appliance.

### Meaning of the symbols

The instructions for actions are subdivided into 7 sections, which are represented by symbols.

	A Before starting
	B Control / Operation
	B Connecting electrical appliances
	C Replacement of filter bag
	C Replacement of disposal bag
	C Replacement of filter element
	D After finishing work

An asterisk (\*) indicates a model variant or special accessories.

Check whether your appliance is equipped with the control elements or special accessories depicted. If not, please proceed to the next action.

**CAUTION:**

This Nilfisk vacuum cleaner is not to be used in explosion-hazardous areas, as serious injury could result.

Under no circumstances may this vacuum cleaner be used safely for the collection of hazardous or toxic materials unless equipped with a HEPA filter. Be sure to install the HEPA filter according to Nilfisk's written instructions.

Do not use this cleaner for the removal of hazardous substances unless you are licensed and/or certified for this work by the all authorities having jurisdiction.

**EMPTYING:**

If this vacuum cleaner is used to collect hazardous material, do not attempt to open or empty its contents without personal protective clothing and respiratory protection. This procedure must be completed in a contained environment. Contact with the cleaner, filters and all other accessories used when picking-up hazardous materials must be handled according to federal (EPA, OSHA), state and local regulations valid for the vacuumed substance.

**ATTENTION EMPLOYER:**

Please ensure these instructions for Use are made available and understood by your employees or any other persons who may use this equipment.

To list all toxic and hazardous materials would be beyond the scope of these instructions. It is the Employer's responsibility to identify, for Employee's and others' information, hazardous or toxic materials which may be collected by this equipment. Such information must be communicated to your Employees and other potential users of this equipment.



## Sobre el presente documento

Este documento contiene informaciones de seguridad relevantes para el equipo y una instrucción de servicio breve.



Antes de poner en marcha el equipo, lea sin falta este documento completamente y guárdelo al alcance de la mano.

### Otras ayudas

En las instrucciones de servicio, que puede descargar desde nuestra página Web: [www.nilfisk.com](http://www.nilfisk.com), encontrará informaciones detalladas sobre el equipo.

Para otro tipo de cuestiones, dirijase, por favor, al servicio técnico de Nilfisk en su país. Véase la cara dorsal de este documento.

## Indicaciones importantes de seguridad

### Señalización de indicaciones

	<b>PELIGRO</b>
	Peligro que puede causar de inmediato lesiones graves e irreversibles o la muerte.
	<b>ADVERTENCIA</b>
	Peligro que puede causar lesiones graves o la muerte.
	<b>PRECAUCIÓN</b>
	Peligro que puede causar lesiones leves o daños materiales.

El aparato

- solamente debe ser utilizado por personas que hayan sido instruidas en su manejo y expresamente encomendadas para esta tarea.
- solamente debe ser utilizado en presencia de un supervisor.
- no debe ser utilizado por niños.

1. Se debe omitir cualquier operación que encierre un riesgo de seguridad.
2. ¡No aspire nunca sin filtro.
3. Debe apagar el equipo y extraer el enchufe de la red en las siguientes situaciones:

- antes de la limpieza y el mantenimiento
- antes de cambiar piezas
- antes de remodelar el equipo
- al producirse espuma o salirse el líquido

La explotación de la máquina está sujeta a las disposiciones nacionales vigentes. Aparte de las instrucciones de servicio y las reglamentaciones obligatorias sobre prevención de accidentes que rigen en el país del usuario, hay que observar también las reglas técnicas reconocidas para el trabajo seguro y técnicamente correcto.

### Uso previsto de la máquina

El equipo es idóneo para aspirar polvos secos y no inflamables y líquidos.

El equipo es idóneo para el uso industrial, p. ej. en

- hoteles, escuelas, hospitales, fábricas, locales comerciales, oficinas

Todo uso que vaya más allá de dicha finalidad será considerado como inadecuado. El fabricante no responderá de los daños resultantes.

Forma también parte de la utilización conforme a la finalidad: la observación de las condiciones de servicio, mantenimiento y entretenimiento prescritas por el fabricante. Véase las instrucciones de seguridad.

### Transporte

1. Antes del transporte, cierre todos los bloqueos del depósito de suciedad.
2. No ladee el aparato si se encuentra líquido en el depósito de suciedad.
3. No eleve el aparato con un gancho de grúa.

### Almacenamiento

1. Almacene el equipo en un lugar seco y protegido contra heladas.

### Conexión eléctrica

1. Se recomienda conectar el aspirador por medio de un interruptor de corriente de defecto.
2. Los conectores y los acoplamientos del cable de alimentación y de los cables alargadores deben ser impermeables.

### Cable de prolongación

1. Utilice como cable de extensión sólo tipos

de cable establecidos por el fabricante o en una ejecución de alta calidad. Véase las instrucciones de servicio.

- En caso de utilización de un cable de prolongación, se ha de tener en cuenta el tamaño transversal mínimo del cable:

Largo del cable	Corte transversal	
	< 16 A	< 25 A
hasta 20 m	1,5 mm <sup>2</sup>	2,5 mm <sup>2</sup>
de 20 hasta 50 m	2,5 mm <sup>2</sup>	4,0 mm <sup>2</sup>

### Garantías

Sirven de garantía y saneamiento nuestras condiciones generales de negocio.

Los cambios de propio arbitrio del equipo, la utilización de piezas de recambio y accesorios incorrectos, así como su uso no reglamentario, excluyen las responsabilidades de fabricante por los daños que resulten de ello.

### Comprobaciones

Comprobaciones electrotécnicas deben ser llevadas a cabo según las prescripciones de Prevención de accidentes (BGV A3) y conforme a DIN VDE 0701 1a Parte y 3a Parte. Estas comprobaciones son necesarias, conforme a DIN VDE 0702, en periodos de tiempos regulares y después de reparaciones y cambios.

## Fuentes de peligro

### Electricidad

PELIGRO	
	<p>Piezas conductoras de tensión en la parte superior del aspirador</p> <p>El contacto con piezas conductoras de tensión es causa de lesiones graves o mortales.</p> <ol style="list-style-type: none"> <li>No salpique nunca con agua la parte superior del aspirador.</li> </ol>

PELIGRO	
	<p>Descarga eléctrica debida a un cable de conexión a la red defectuoso.</p> <p>El tocar un cable de conexión a la red defectuoso puede causar lesiones graves o mortales.</p> <ol style="list-style-type: none"> <li>No deteriorar el cable eléctrico (p. ej. pisándolo, tirando de él o aplastándolo).</li> <li>Comprobar en intervalos regulares si el cable tiene algún deterioro o desgaste.</li> <li>Haga cambiar un cable de conexión a la red defectuoso por el servicio técnico de Nilfisk o por un técnico electricista antes de seguir utilizando el equipo.</li> </ol>

PRECAUCIÓN	
	<p>Caja de enchufe en el equipo<sup>*)</sup>.</p> <p>La caja de enchufe en el equipo está diseñada sólo para los fines establecidos en las instrucciones de uso.</p> <ol style="list-style-type: none"> <li>La conexión de otros aparatos puede ser causa de daños materiales.</li> <li>Antes de enchufar un aparato, desconecte el aspirador y el aparato a conectar.</li> <li>Lea las instrucciones de uso del aparato a conectar y las indicaciones de seguridad contenidas en ellas.</li> </ol>

PRECAUCIÓN	
	<p>Daño debido a una tensión de red inadecuada</p> <p>El equipo puede resultar dañado si se conecta a una tensión de red inadecuada.</p> <ol style="list-style-type: none"> <li>Asegúrese de que la tensión de la red coincida con la que indica la placa de características.</li> </ol>

**Aspirar líquidos**

<b>PRECAUCIÓN</b>	
	<p>Aspirar líquidos.</p> <p>No está permitido aspirar líquidos combustibles.</p> <ol style="list-style-type: none"> <li>1. Antes de aspirar líquidos, saque siempre la bolsa de filtro/bolsa de eliminación de residuos y compruebe el funcionamiento del flotador o de la limitación del nivel de agua.</li> <li>2. Se recomienda la utilización por separado de un elemento filtrante o de un tamiz filtrante.</li> <li>3. En caso de formación de espuma, termine inmediatamente el trabajo y vacíe el depósito.</li> </ol>

**Materiales peligrosos**

<b>ADVERTENCIA</b>	
	<p>Materiales peligrosos</p> <p>La aspiración de materiales peligrosos puede causar lesiones graves o mortales.</p> <ol style="list-style-type: none"> <li>1. No se pueden aspirar los siguientes materiales: <ul style="list-style-type: none"> <li>- Polvos nocivos para la salud</li> <li>- materiales calientes (cigarros ardiendo, cenizas calientes, etc.)</li> <li>- líquidos combustibles, explosivos y agresivos (p. ej. gasolina, disolventes, ácidos, lejías, etc.)</li> <li>- polvos combustibles y explosivos (p. ej. polvo de magnesio o aluminio, etc.)</li> </ul> </li> </ol>

**Piezas de recambio y accesorios**

<b>PRECAUCIÓN</b>	
	<p>Piezas de recambio y accesorios</p> <p>El uso de piezas de recambio y accesorios no originales puede mermar la seguridad del equipo.</p> <ol style="list-style-type: none"> <li>1. Utilice únicamente piezas de recambio y accesorios de Nilfisk.</li> <li>2. Utilice solamente los cepillos suministrados con la máquina o las establecidas en las instrucciones de manejo.</li> </ol>

**Vaciar el depósito de suciedad**

<b>PRECAUCIÓN</b>	
	<p>Materiales de aspiración polucio- nantes</p> <p>Los materiales de aspiración pueden constituir un peligro para el medio.</p> <ol style="list-style-type: none"> <li>1. Elimine el material aspirado siguiendo las disposiciones legales sobre recogida de residuos.</li> </ol>

**Entrega del aparato para su reciclaje**

Inutilice inmediatamente el aparato fuera de uso.

1. Extraiga el enchufe
2. Corte el cable de conexión a la corriente.
3. ¡No tire aparatos eléctricos a la basura doméstica!









Conforme a la directriz europea 2012/19/CE sobre aparatos viejos eléctricos y electrónicos, se tienen que recoger los aparatos eléctricos usados y entregar a un reciclaje según las normas medioambientales.

## Instrucción breve

En las páginas 2 – 12 encontrará una instrucción breve, neutra respecto al lenguaje, que le sirve de apoyo en la puesta en marcha, en el servicio y el almacenamiento del equipo. Esta instrucción breve no debe ser considerada como una sustitución de las instrucciones de servicio por separado, que describen el equipo detalladamente. Las instrucciones de servicio suministran, además, informaciones adicionales sobre el manejo, mantenimiento y reparación del equipo.

### Significación de los símbolos

Las instrucciones de acción están divididas en 7 áreas, que están representadas por símbolos.

	A Antes de la puesta en servicio por primera vez
	B Manejo / servicio
	B Conexión de un aparato eléctrico
	C Cambiar la bolsa de filtro
	C Cambiar la bolsa de eliminación de residuos
	C Cambiar el elemento filtrante
	D Después del trabajo

Un asterisco (\*) hace referencia a variantes de modelos o a accesorios especiales. Compruebe que su equipo está provisto de los elementos de manejo y accesorios especiales mostrados. Si éste no es el caso, continúe con el siguiente paso.

**PRECAUCIÓN:**

El aspirador Nilfisk no se debe usar en zonas con peligro de explosión ya que podrían producirse lesiones graves.

Este aspirador no debe usarse, bajo ninguna circunstancia, para recoger materiales peligrosos o tóxicos excepto si está equipado con un filtro HEPA. Asegúrese de que instala el filtro HEPA según las instrucciones escritas de Nilfisk.

No use este aspirador para recoger sustancias peligrosas excepto si las autoridades competentes le autorizan o certifican para hacerlo.

**VACIADO:**

Este aspirador se utiliza para recoger material peligroso, no intente abrirlo ni vaciarlo sin ropa protectora y máscara. Este procedimiento debe realizarse en un entorno controlado. El contacto con el aspirador, los filtros y el resto de los accesorios que se usen para recoger el material peligroso debe realizarse según las leyes federales (EPA, OSHA), estatales y locales aplicables a las sustancias que se van a recoger.

**ATENCIÓN EMPRESARIO:**

Asegúrese de que estas instrucciones de uso están disponibles y son comprendidas por sus empleados o por cualquier otra persona que utilice este equipo.

Enumerar todos los materiales tóxicos y peligrosos aquí es imposible. Es responsabilidad del empresario identificar, tanto de cara al empleado como para otros, los materiales peligrosos o tóxicos que pueden ser recogidos con este equipo. Debe comunicar esta información a sus empleados y a todos los usuarios potenciales de los equipos.

## Ce document

Ce document contient les informations relatives à la sécurité importantes pour l'appareil et une brève notice d'utilisation.



Avant de mettre l'appareil en service, lisez absolument ce document et conservez-le à portée de la main.

### Autre soutien

Vous trouverez des informations détaillées sur l'appareil dans la notice d'utilisation que vous pouvez télécharger de nos pages Internet à [www.nilfisk.com](http://www.nilfisk.com).

Pour d'autres questions, veuillez vous adresser au service après-vente de Nilfisk compétent pour votre pays. Voir au dos de ce document.

## Consignes de sécurité importantes

### Symboles de mise en garde

	<b>DANGER</b>
	Danger susceptible d'entraîner directement des blessures graves et irréversibles ou la mort
	<b>AVERTISSEMENT</b>
	Danger susceptible d'entraîner des blessures graves ou la mort.
	<b>ATTENTION</b>
	Danger susceptible d'entraîner des blessures légères ou des dommages matériels.

L'appareil ne doit

- être utilisé que par des personnes qui ont été initiées à son maniement et expressément chargées de son utilisation
  - être exploité que sous surveillance
  - pas être utilisé par des enfants
1. S'abstenir de toute méthode de travail douteuse quant à la sécurité.
  2. N'aspirez jamais sans filtre.
  3. Dans les situations suivantes, arrêtez l'appareil et débranchez la fiche de secteur :
    - avant le nettoyage et la maintenance

- avant le remplacement d'éléments
- avant la transformation de l'appareil
- en cas de formation de mousse ou d'échappement de liquide

Le fonctionnement de l'appareil est soumis aux dispositions nationales en vigueur. Outre la notice d'utilisation et les règlements obligatoires de prévention des accidents en vigueur dans le pays d'utilisation, il convient d'observer les règles techniques reconnues pour des travaux effectués en toute sécurité et selon les règles de l'art.

### Affectation

L'appareil convient à l'aspiration de poussières sèches, non inflammables, et de liquides.

L'appareil convient à l'usage industriel, p. ex. dans

- hôtels, écoles, hôpitaux, usines, magasins, bureaux, agences de location

Toute utilisation allant au-delà est considérée comme non conforme à la destination. Le fabricant décline toute responsabilité pour les dommages qui en résulteraient.

L'utilisation conforme à la destination implique aussi le respect des conditions de service, de maintenance et d'entretien prescrites par le fabricant. Endommagement de revêtements de sol fragiles. Voir notice d'utilisation.

### Transport

1. Avant le transport, refermez tous les verrouillages de la cuve à saletés.
2. Ne basculez pas l'appareil si la cuve à saletés contient encore du liquide.
3. Ne soulevez pas l'appareil avec des crochets de grue.

### Entreposage

1. Entrepochez l'appareil au sec et à l'abri du gel.

### Raccordement électrique

1. Il est recommandé de raccorder l'appareil au moyen d'un disjoncteur de protection contre le courant de défaut.
2. Choisissez l'agencement des composants qui conduisent le courant (prises, fiches et accouplements) et posez la rallonge de telle manière que la classe de protection soit conservée.
3. Les fiches et accouplements des cordons

de branchement au secteur et des rallonges doivent être étanches.

### Câble de rallonge

1. Utilisez comme câble de rallonge uniquement le modèle indiqué par le fabricant ou un modèle supérieur. Voir notice d'utilisation.
2. Veillez à ce que le câble ait la section minimale requise :

Longueur du câble m	Section	
	< 16 A	< 25 A
jusqu'à 20 m	1,5 mm <sup>2</sup>	2,5 mm <sup>2</sup>
20 à 50 m	2,5 mm <sup>2</sup>	4,0 mm <sup>2</sup>

### Garantie

La garantie et la caution sont réglementées par nos Conditions commerciales générales. Toute modification arbitraire sur l'appareil, l'utilisation de pièces de rechange et accessoires inadéquats ainsi que l'utilisation non conforme à la destination excluent une responsabilité du fabricant pour les dommages qui en résulteraient.

### Contrôles

Des contrôles électrotechniques doivent être effectués conformément aux règlements de prévention des accidents («BGV A3») et à DIN VDE 0701, parties 1 et 3. La norme DIN VDE 0702 impose ces contrôles à intervalles réguliers et après une réparation ou une modification.

## Sources de danger

### Electricité

DANGER	
	<p>Éléments conduisant la tension dans la partie supérieure de l'aspirateur.</p> <p>Le contact avec des éléments conduisant la tension entraîne des blessures graves ou mortelles.</p> <ol style="list-style-type: none"> <li>1. Ne pulvérisez jamais de l'eau sur la partie supérieure de l'aspirateur.</li> </ol>

DANGER	
	<p>Décharge électrique due à un cordon défectueux de raccordement au secteur.</p> <p>Le contact avec un cordon défectueux de raccordement au secteur peut entraîner des blessures graves ou mortelles.</p> <ol style="list-style-type: none"> <li>1. Ne pas endommager le câble d'alimentation électrique (p. ex. en l'écrasant, en le tirant ou en le serrant).</li> <li>2. S'assurer régulièrement que le câble d'alimentation électrique ne présente ni détériorations ni signes d'usure.</li> <li>3. Avant de continuer à vous servir de l'appareil, faites remplacer le cordon défectueux de raccordement au secteur par le service après-vente de Nilfisk ou par un électricien.</li> </ol>

ATTENTION	
	<p>Prise intégrée dans l'appareil<sup>*)</sup>.</p> <p>La prise intégrée dans l'appareil n'est dimensionnée que pour les buts indiqués dans la notice d'utilisation. Le raccordement d'autres appareils peut entraîner des dommages matériels.</p> <ol style="list-style-type: none"> <li>1. Avant de brancher un appareil, arrêtez l'aspirateur et l'appareil à raccorder.</li> <li>2. Lisez la notice d'utilisation de l'appareil à raccorder et observez les consignes de sécurité qu'elle contient.</li> </ol>

ATTENTION	
	<p>Endommagement dû à une tension secteur inadéquate.</p> <p>L'appareil peut être endommagé s'il est raccordé à une tension secteur inadéquate.</p> <ol style="list-style-type: none"> <li>1. S'assurer que la tension indiquée sur la plaque signalétique concorde avec celle du réseau local.</li> </ol>

### Aspiration de liquides

	<b>ATTENTION</b>
<p>Aspiration de liquides. N'aspirez pas de liquides inflammables.</p> <ol style="list-style-type: none"> <li>1. Avant d'aspirer des liquides, il faut retirer systématiquement le sac filtre ou le sac d'évacuation et vérifier le fonctionnement du flotteur ou la limitation du niveau d'eau.</li> <li>2. Il est conseillé d'utiliser un élément filtrant séparé ou un tamis de filtration.</li> <li>3. Si de la mousse se forme, arrêtez immédiatement le travail et videz la cuve.</li> </ol>	

### Matériaux dangereux

	<b>AVERTISSEMENT</b>
<p>Matériaux dangereux. L'aspiration de matériaux dangereux peut entraîner des blessures graves ou mortelles.</p> <ol style="list-style-type: none"> <li>1. Il est interdit d'aspirer les matières suivantes : <ul style="list-style-type: none"> <li>- poussières insalubres</li> <li>- matières brûlantes (cigarettes incandescentes, cendres chaudes etc.)</li> <li>- liquides inflammables, explosifs, agressifs (p. ex. essence, solvants, acides, bases etc.)</li> <li>- poussières inflammables, explosives (p. ex. poussière de magnésium, d'aluminium etc.)</li> </ul> </li> </ol>	

### Pièces de rechange et accessoires

	<b>ATTENTION</b>
<p>Pièces de rechange et accessoires.</p> <p>L'utilisation de pièces de rechange et d'accessoires qui ne sont pas d'origine peut compromettre la sécurité de l'appareil.</p> <ol style="list-style-type: none"> <li>1. N'utilisez que les brosses fournies avec l'appareil ou spécifiées dans la notice d'utilisation.</li> <li>2. Employez uniquement des pièces de rechange et accessoires de Nilfisk.</li> </ol>	

### Vidage de la cuve à saletés

	<b>ATTENTION</b>
<p>Matériaux aspirés dangereux pour l'environnement.</p> <p>Des matériaux aspirés peuvent présenter un danger pour l'environnement.</p> <ol style="list-style-type: none"> <li>1. Éliminez les matières aspirées conformément aux dispositions légales.</li> </ol>	

### Affectation de la machine au recyclage

Rendez immédiatement inutilisable l'appareil qui ne sert plus.

1. Débranchez la fiche secteur.
2. Sectionnez le cordon.
3. Ne jetez pas les appareils électriques dans les ordures ménagères !



D'après la directive européenne 2012/19/CE sur les déchets d'équipements électriques et électroniques usés, les appareils électriques doivent faire l'objet d'une collecte sélective et d'un recyclage écologique.







## Brève notice

Vous trouverez aux pages 2 – 12 une brève notice en langage neutre, qui vous aidera pour la mise en service, la commande et l'entreposage de l'appareil.

Cette brève notice ne remplace pas la notice d'utilisation séparée qui décrit l'appareil en détail. La notice d'utilisation fournit en outre des informations complémentaires sur la commande, la maintenance et la réparation de l'appareil.

### Signification des symboles

Les instructions de manipulation sont subdivisées en 7 domaines qui sont représentés par des symboles.

	A Avant la mise en service
	B Commande / Service
	B Raccordement d'un appareil électrique
	C Remplacement du sac filtre
	C Remplacement du sac d'évacuation
	C Remplacement de l'élément filtrant
	D Après le travail

Un astérisque (\*) renvoie à une variante de modèle ou à un accessoire optionnel.

Assurez-vous que votre appareil est doté des éléments de commande ou accessoires optionnels montrés. Si ce n'est pas le cas, continuez avec l'étape suivante.

**ATTENTION !**

N'utilisez jamais cet aspirateur Nilfisk dans des endroits avec risque d'explosion, sous peine de vous blesser gravement.

Cet aspirateur ne peut en aucune circonstance être utilisé sans risque pour l'aspiration de substances dangereuses ou toxiques, sans être équipé d'un filtre HEPA. Assurez-vous d'installer le filtre HEPA conformément aux instructions écrites de Nilfisk.

N'utilisez pas l'aspirateur à enlever des substances dangereuses sans autorisation et/ou qualification certifiée pour ce travail par les autorités compétentes.

**VIDANGE :**

Si cet aspirateur est utilisé pour l'aspiration de substances dangereuses, n'essayez pas de l'ouvrir ou de vider son contenu sans vêtements de protection et protection respiratoire. La vidange doit être exécuté dans un environnement isolé. Tout contact avec l'aspirateur, les filtres et autres accessoires utilisés pour l'aspiration des substances dangereuses doit être effectué conformément aux réglementations locales, nationales et fédérales (EPA, OSHA) relatives aux substances aspirées.

**MISE EN GARDE À L'ATTENTION DE L'EMPLOYEUR :**

Veuillez vous assurer que ce Mode d'emploi est mis à disposition et compris par l'ensemble de vos employés, ou par toute autre personne amenée à utiliser ce matériel.

L'énumération exhaustive des substances toxiques et dangereuses dépasserait l'objet du Mode d'emploi. Il incombe à l'employeur d'identifier, pour l'information de ses employés ou autres personnes, les substances dangereuses ou toxiques susceptibles d'être aspirées avec ce matériel. De telles informations sont à communiquer à vos employés ainsi qu'à d'autres utilisateurs potentiels de l'aspirateur.

## WARRANTY

Nilfisk warrants that its equipment will be free of defects in workmanship or material for a period of two years from the date of delivery. If the vacuum fails to meet these warranty standards, Nilfisk shall, upon notification within such time period, correct such non-conformity, as its option, either by repairing any defective part or parts, or by replacing a part or parts provided that the equipment is returned to an authorized Nilfisk service facility. In all cases freight both ways will be at expense of the customer. Equipment shall not be returned without advance notice to, and consent of Nilfisk.

**EXCEPT AS SPECIFICALLY SET FORTH HERIN, NILFISK MAKES NO WARRANTIES, EITHER EXPRESSED OR IMPLIED, AS TO ANY MATTER WHATSOEVER, INCLUDING WITHOUT LIMITATION ANY AND ALL WARRANTIES OF MERCHANTABILITY, FITNESS OF PURPOSE, OR OTHER WARRANTIES, ALL OF WHICH ARE EXPRESSLY DISCLAIMED AND EXCLUDED. NEITHER PARTY SHALL BE LIABLE TO THE OTHER FOR SPECIAL, INDIRECT, INCIDENTAL OR CONSEQUENTIAL DAMAGES, INCLUDING BUT NOT LIMITED TO LOSS OF PRODUCTION, LOSS OF PROFITS OR ANY OTHER SIMILAR INDIRECT LOSSES WHICH MIGHT OCCUR AS A RESULT OF DEFECTS, PARTIAL OR TOTAL FAILURE OF THE PRODUCT TO PERFORM AS SPECIFIED.**

Correction of non-conformities or defects in the manner and for the period of time provided above, shall constitute fulfillment of all Liabilities of Nilfisk to the customer, whether based on contract, negligence or otherwise with respect to, or arising out of such equipment. The remedies set forth herein are exclusive, and the liability of Nilfisk with respect to this sale or anything done in connection therewith, whether in contract, in tort, under any warranty, or otherwise, shall not, except as expressly provided herein, exceed the price of the equipment or part on which such liability is based.

This warranty does not cover repairs due to normal wear and tear, accident, neglect, misuse or abuse, incorrect installation or use other than described in the instruction booklet. Breaks in hoses and cables are not covered. This warranty is rendered void if the motor number plate is removed or defaced or if repairs are made or attempted by persons not authorized by Nilfisk.

Some states do not allow exclusion of implied warranties or limitations on how long an implied warranty lasts so the above exclusions or limitation of implied warranties may not apply. Some states do not allow exclusion or limitation of incidental or consequential damages so the above exclusion or limitation of incidental or consequential damages may not apply. Limited warranties set forth above give specific legal rights. Customer may have other rights which vary from state to state.

---

## HEAD QUARTER

### DENMARK

Nilfisk A/S  
Tel.: +45 43 23 81 00  
www.nilfisk.com

## SALES COMPANIES

### ARGENTINA

Nilfisk Argentina  
Tel.: +54 11 4737 1877  
www.nilfisk.com

### AUSTRALIA

Nilfisk Pty Ltd  
Tel.: +61 1300 556 710  
www.nilfisk.com

### AUSTRIA

Nilfisk GmbH  
Tel.: +43 (0)662/45 64 00-90  
www.nilfisk.com

### BELGIUM

Nilfisk nv/sa  
Tel.: +32 (0) 2 467 60 50  
www.nilfisk.com

### BRAZIL

Nilfisk do Brasil  
Tel.: +55 11 3959-0300  
www.nilfisk.com

### CANADA

Nilfisk Canada Company  
Tel.: +1 800-668-8400  
www.nilfisk.com

### CHILE

Nilfisk S.A. (Comercial KCS Ltda)  
Tel.: +56 2 2684 5000  
www.nilfisk.com

### CHINA

Nilfisk  
Tel.: +86 400 080 3200  
www.nilfisk.com

### CZECH REPUBLIC

Nilfisk s.r.o.  
Tel.: +420 244 090 912  
www.nilfisk.com

### DENMARK

Nilfisk Danmark A/S  
Tel.: +45 72 18 21 00  
www.nilfisk.com

### FINLAND

Nilfisk Oy Ab  
Tel.: +358 207 890 602  
www.nilfisk.com

### FRANCE

Nilfisk SAS  
Tel.: +33 169 59 87 00  
www.nilfisk.com

### GERMANY

Nilfisk GmbH  
Tel.: +49 (0)7306-72-444  
www.nilfisk.com

### GREECE

Nilfisk A.E.  
Tel.: +30 210 911 9600  
www.nilfisk.com

### NETHERLANDS

Nilfisk B.V.  
Tel.: +31 036-5460700  
www.nilfisk.com

### HUNGARY

Nilfisk Kft.  
Tel.: +36 24 507 452  
www.nilfisk.com

### INDIA

Nilfisk India Limited  
Tel.: +91 80 4127 6510  
www.nilfisk.com

### IRELAND

Nilfisk  
Tel.: +35 01 294 3838  
www.nilfisk.com

### ITALY

Nilfisk SpA  
Tel.: +39 0523 1612000  
www.nilfisk.com

### JAPAN

Nilfisk Inc.  
Tel.: +81 045-620-3658  
www.nilfisk.com

### MALAYSIA

Nilfisk Sdn Bhd  
Tel.: +603 6275 3120  
www.nilfisk.com

### MEXICO

Nilfisk de Mexico, S. de R.L. de C.V.  
Tel.: +52 442 427 7774  
www.nilfisk.com

### NEW ZEALAND

Nilfisk Limited  
Tel.: +64 (09) 525 1130  
www.nilfisk.com

### NORWAY

Nilfisk AS  
Tel.: +47 22 75 17 80  
www.nilfisk.com

### PERU

Nilfisk S.A.C.  
Tel.: + 51 (1) 710 8283  
www.nilfisk.com

### POLAND

Nilfisk Sp. Z.O.O.  
Tel.: +48 22 104 22 00  
www.nilfisk.com

### PORTUGAL

Nilfisk Lda.  
Tel.: +351 219 112 670  
www.nilfisk.com

### SINGAPORE

Nilfisk Pte Ltd  
Tel.: +65 62681006  
www.nilfisk.com

### SLOVAKIA

Nilfisk s.r.o.  
Tel.: +421 948 339 353  
www.nilfisk.com

### SOUTH AFRICA

Nilfisk Middle East & Africa  
Tel.: +971 4264 4172  
www.nilfisk.com

### SOUTH KOREA

Nilfisk Korea  
Tel.: +82 02-3474-4141  
www.nilfisk.com

### SPAIN

Nilfisk S.A.U  
Tel.: +34 900 506 776  
www.nilfisk.com

### SWEDEN

Nilfisk AB  
Tel.: +46 031-706 73 00  
www.nilfisk.com

### SWITZERLAND

Nilfisk AG  
Tel.: +41 (0)71 923 84 44  
www.nilfisk.com

### THAILAND

Nilfisk Co. Ltd.  
Tel.: +66 0-2275-5630  
www.nilfisk.com

### TURKEY

Nilfisk A.S.  
Tel.: +90 216 275 76 00  
www.nilfisk.com

### UNITED ARAB EMIRATES

Nilfisk Middle East Branch  
Tel.: +971 4264 4172  
www.nilfisk.com

### UNITED KINGDOM

Nilfisk Ltd.  
Tel.: +44 01768 868995  
www.nilfisk.com

### UNITED STATES

Nilfisk, Inc.  
Tel.: +1 800-989-2235  
www.nilfisk.com

### VIETNAM

Nilfisk Vietnam  
Tel.: +84 0866 461 566  
www.nilfisk.com